

反光杯

REFLECTOR

支架

HOLDER

透镜

LENS



广州乔光光电科技发展有限公司
Optosource Photoelectricity Technology Co.,Ltd

Ver.25.5



专属于您的光学器件定制专家

- +86 20 82660966
- +86 18820021222
- amyzhou@hkoptosource.com
- www.opto-source.com



www.opto-source.com

© 28/05/2025 Optosource, Inc. All rights reserved.

办公室：中国香港九龙观塘骏业街56号中海日升中心20楼C室
 工厂：广州市增城经济技术开发区香山大道42号雄兴孵化园4栋
 Office: Flat/RM C, 20/F, COS Centre, 56 Tsun Yip Street, Kwun Tong, Kowloon, Hong Kong
 Factory: Building 4, Xiongxing Incubation Park, No.42 Xiangshan Avenue, Zengcheng Economic and Technological Development Zone, Guangzhou, China

Optosource: 15年专注光学器件，革新LED照明体验

作为全球LED照明光学器件解决方案服务商，Optosource深耕行业15年，秉持“舒适光环境与高效光效平衡”理念，提供光学设计、制造、技术服务全链条支持，致力于让光兼具功能与人文关怀。

核心优势

- 光学创新：专业团队以性能优化、成本控制、工艺简化为设计三角，解决技术痛点；聚焦视觉舒适、耐用性、环保合规，适配多元场景。
- 全流程品控：智能化制造体系+高品质材料，通过严苛质检与国际认证，树立可靠标杆。
- 全球化服务：定制方案设计+快速交付，全程跟进售后，助力客户提效降本。

企业价值观

- 创新驱动：突破技术边界，引领行业趋势；
- 品质至上：细节严控，打造信赖产品；
- 绿色发展：低耗长寿可回收，助力碳中和。

Optosource以专业积淀与创新力，携手客户用科技之光点亮空间，让高效与舒适共生。

联系我们，获取智能精准的LED照明光学解决方案。

Optosource: 15 Years of Optical Craftsmanship, Redefining New Heights in LED Lighting

As a global leading provider of LED lighting optical component solutions, Optosource has deeply rooted itself in the industry for fifteen years. Upholding the core philosophy of "perfect balance between comfortable light environment and high-efficiency light effect," we provide global customers with full-chain professional support, from optical design and precision manufacturing to technical services. Our mission is to ensure that every beam of light integrates functionality and humanistic care, enhancing visual experience and environmental value while illuminating spaces.

Core Advantages: Technology Empowerment, Smart Manufacturing for the Future

1. Optical Innovation, Precise Need Fulfillment

Our professional team integrates creativity and science, using optical performance optimization, production cost control, and manufacturing process simplification as the design triangle to address customers' technical pain points in optical applications.

Focusing on three dimensions—visual comfort, product durability, and environmental compliance—we ensure stable and efficient operation of products in diverse scenarios such as commercial lighting, industrial lighting, and indoor/outdoor lighting.

2. Full-Process Quality Control, Crafting Reliable Quality

We introduce advanced production equipment and build an intelligent manufacturing system to achieve seamless integration from conceptual design to mass production.

By strictly selecting high-quality materials and implementing standardized quality inspection processes and rigorous testing, we ensure every product meets international certification standards (e.g., EMC, LCA), establishing an industry benchmark for reliability.

3. Globalized Services, Rapid Market Response

Based locally and radiating globally, we offer customized optical solution design and fast delivery services for domestic and international customers, shortening project cycles and improving cost-effectiveness.

Our professional technical support team follows up throughout the process, from product selection to after-sales maintenance, to build long-term partnerships through professional services.

Corporate Values: Light as the Foundation, Building a Sustainable Future Together

- Innovation-Driven: Continuously explore the frontiers of optical technology and lead industry trends with breakthrough designs.
- Quality First: Integrate "excellent quality and high reliability" into every production detail to create trustworthy optical components.
- Green Development: Practice environmental protection concepts, promote the upgrading of LED lighting toward low energy consumption, long lifespan, and recyclability, and contribute to global carbon neutrality goals.

Optosource is more than a manufacturer of optical components—we are creators of light value. With fifteen years of industry accumulation as our foundation and innovation as our driving force, we are committed to joining hands with global customers to illuminate every space with professional light, where efficiency and comfort coexist, and technology and humanity symbiose.

Contact us to unlock smarter and more precise LED lighting optical solutions.



专业灯光设计
Professional Lighting Design



优秀的研发和制造能力
Superb R&D and manufacturing capabilities



专属的ETO定制
Exclusive ETO



专业的服务体验
Systematic service

全球合作伙伴/GLOBAL PARTNERS.

| | | | |
|--|---|---|---|
| Globe Agent Future Electronics www.futureelectronics.com | India Aq Tronics Technologies Pvt. Ltd. www.aqtronics.com Eureka Enterprises www.lensoflexoptics.com | Italy Melchioni S.p.a www.melchionieletronics.com | Japan Future Electronics www.futureelectronics.com |
| Singapore Supreme Components International www.supremecomponents.com | Spain, Portugal and France Matrix Electronica S.L. www.matrix.es | Turkey Er Elektronik San.Tic.A.S. www.erelektronik.es | United Kingdom DAU Components Ltd www.dau-components.com |



产品命名规则/PRODUCT NAMING GUIDELINES

示例品名/The part number is explained as follows:R03024AN-10 / BR06215-C1N-BV13

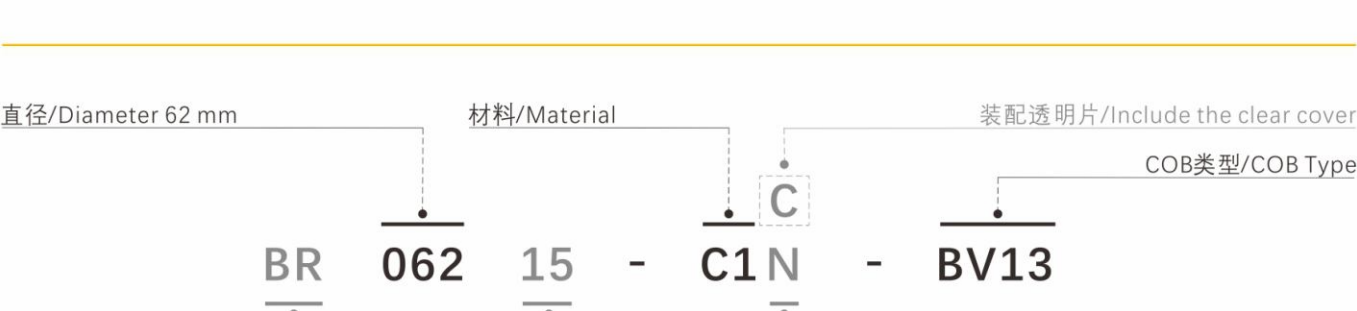
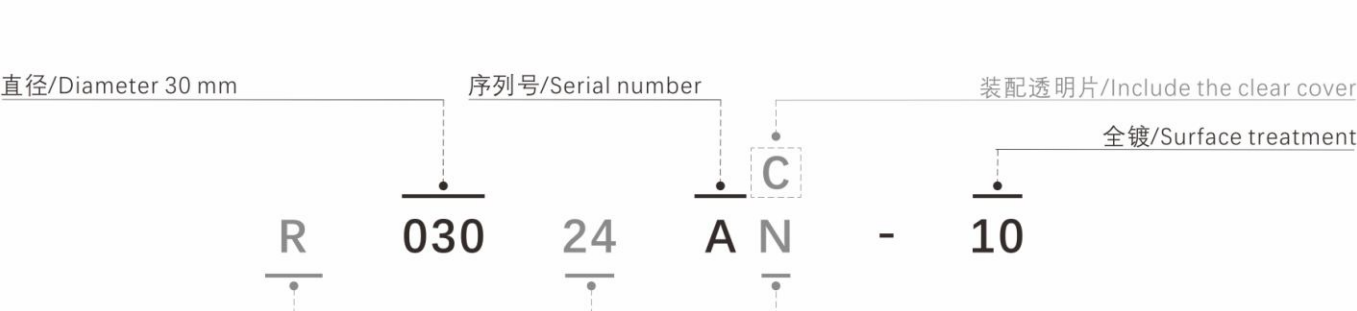

目录页/CONTENTS

反光杯/Reflector

| | | |
|-------------|-------|---------|
| ø30~ø40mm | ----- | P.10~16 |
| ø41~ø50mm | ----- | P.17~28 |
| ø61~ø65mm | ----- | P.29~34 |
| ø75~ø85mm | ----- | P.35~44 |
| ø93~ø110mm | ----- | P.45~49 |
| ø101~ø150mm | ----- | P.50~51 |

透镜/Lens

P.52~54

支架/Holders

P.55~58

免焊接支架/Solder-Free Holders

P.59



自定义多种电镀颜色



CUSTOMIZE MORE COLORS

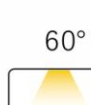
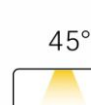
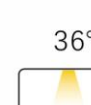
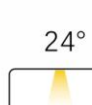

多种不同的光学角度，定制您的自有光学设备

DIFFERENT OPTICAL ANGLES, CUSTOMIZE YOUR OWN OPTICAL DEVICES

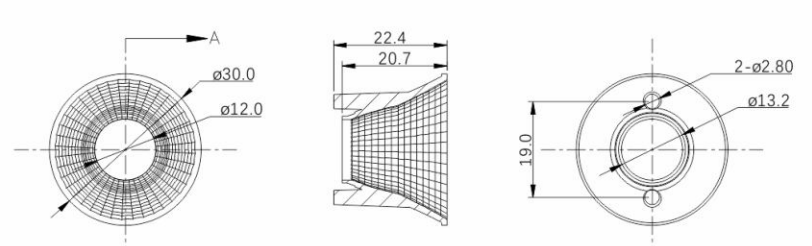

R030AN-10

| Model型号 | FWHM Angle角度 | Lens透镜 | Coverg灯盖 |
|-------------|--------------|--------|----------|
| R03028AN-10 | 28° | - | - |
| R03040AN-10 | 40° | - | - |
| R03056AN-10 | 56° | - | - |

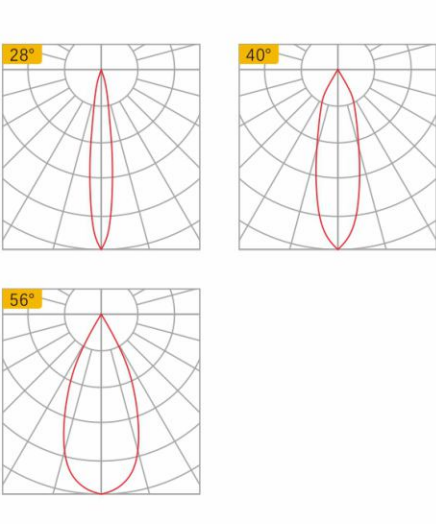

P.10 | Reflector

光源/SOURCE / LES 8~12mm

| | |
|-----------|---|
| Bridgelux | V10 / E8 CA / E10 / V10 gen7- gen8- gen9 |
| Citizen | CLU028 / CLU021 / CLU02Q / CLU703 / CLU702 / CLU701 |
| CREE | CHA0612 / CMA1516 / CMB1516 / CMT1420 / CMU1013 / CXB1520 |
| Lumens | ERC1507HO / ERC1512HO / 1309H2 / 1318H2 |
| Lumileds | L202s / L02x09 / L04x09 / S04H9 / M02F09 / M03F09 |

| | |
|----------|--|
| Luminus | CXM-6-AC30 gen3 / CXM-6 gen6 / CHM-6-BH40 / CXM-6 LUX / CHM-9 gen3 / CIM-9 gen4 / CLM-9-AC30 gen3 / CLM-9-AC40 gen4 / CXM-9-TC60 gen6 / CLM-9-TC50 LUX |
| Osram | S9 |
| Nichia | NFCWS024B / NJCWS024Z / NFCWL036B / NVEWL016Z |
| Tridonic | SLE 06mm / SLE 09mm |
| Samsung | LC003D / LC006D / LC009D / LC013D |
| Seoul | SAWS1063A |

支架/HOLDERS

| Type | COB size(mm) | COB LES(mm) | Size(mm) | Material | Screw size |
|-------------|--------------|-------------|-----------|----------|------------|
| BRHV068-F | 12.5x12.5 | 3-9 | ø28x2 | PA9T | M2.5 |
| BCH1020-A | 13.5x13.5 | 3-11.5 | ø28x2 | PA9T | M2.5 |
| CHL020-A | 13.5x13.5 | 3-11.5 | ø28x2 | PA9T | M2.5 |
| CHL020-P | 13.5x13.5 | 3-11.5 | ø25.3x2.0 | PC | M2.5 |
| H121313E-01 | 13.5x13.5 | 3-11 | ø35x4.3 | PC | M2.5 |
| H121414E-01 | 13.5x13.5 | 3-12 | ø27x4.0 | PC | M2.5 |
| H111512C-02 | 15x12 | 3-11 | ø28x2 | PA9T | M2.5 |
| H111512D-01 | 15x12 | 3-11 | ø25x3.2 | PC | M2.5 |
| SHHMINI-P | 15x12 | 3-10 | ø25.6x2.0 | PC | M2.5 |
| BRHV010-C | 15.8x15.8 | 3-12 | ø28x2 | PA9T | M2.5 |
| BRHV010-P | 15.8x15.8 | 3-12 | ø28x3.5 | PC | M2.5 |
| CRH1507-P | 15.85x15.85 | 3-11 | ø26.9x2.0 | PC | M2.5 |
| H111616A-01 | 15.85x15.85 | 3-11 | ø27.5x4.0 | PC | M2.5 |
| H111616B-01 | 15.85x15.85 | 3-11 | ø27.5x4.0 | PC | M2.5 |
| H111616C-01 | 15.85x15.85 | 3-11 | ø25x4.0 | PC | M2.5 |
| H121616B-01 | 15.85x15.85 | 3-12 | ø27x3.5 | PC | M2.5 |
| NHN036-P | 19x16 | 3-11 | ø30.2x3.0 | PC | M2.5 |
| NHN066-P | 19x16 | 3-11 | ø30.2x3.0 | PC | M2.5 |
| PHI1203-P | 19x16 | 3-11 | ø30.2x3.2 | PC | M2.5 |

QR032-C1N

| Model型号 | FWHM Angle角度 | Lens透镜 | Coverg灯盖 |
|-------------|--------------|--------|----------|
| QR03224-C1N | 24° | - | - |
| QR03240-C1N | 40° | - | - |
| QR03260-C1N | 60° | - | - |

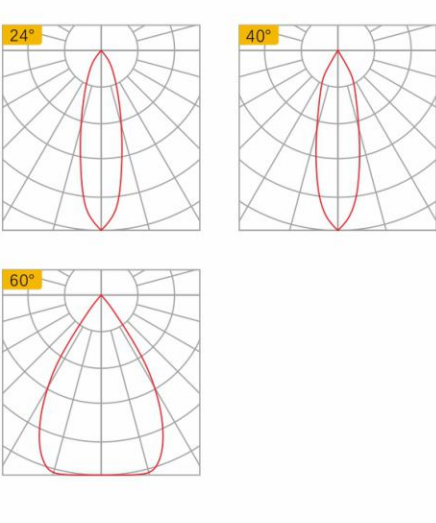

P.11 | Reflector

光源/SOURCE / LES 8~12mm

| | |
|-----------|---|
| Bridgelux | V10 / E8 CA / E10 / V10 gen7- gen8- gen9 |
| Citizen | CLU028 / CLU021 / CLU02Q / CLU703 / CLU702 / CLU701 |
| CREE | CHA0612 / CMA1516 / CMB1516 / CMT1420 / CMU1013 / CXB1520 |
| Lumens | ERC1507HO / ERC1512HO / 1309H2 / 1318H2 |
| Lumileds | L202s / L02x09 / L04x09 / S04H9 / M02F09 / M03F09 |

| | |
|----------|--|
| Luminus | CXM-6-AC30 gen3 / CXM-6 gen6 / CHM-6-BH40 / CXM-6 LUX / CHM-9 gen3 / CIM-9 gen4 / CLM-9-AC30 gen3 / CLM-9-AC40 gen4 / CXM-9-TC60 gen6 / CLM-9-TC50 LUX |
| Osram | S9 |
| Nichia | NFCWS024B / NJCWS024Z / NFCWL036B / NVEWL016Z |
| Tridonic | SLE 06mm / SLE 09mm |
| Samsung | LC003D / LC006D / LC009D / LC013D |
| Seoul | SAWS1063A |

支架/HOLDERS

| Type | COB size(mm) | COB LES(mm) | Size(mm) | Material | Screw size |
|-------------|--------------|-------------|-----------|----------|------------|
| BRHV068-F | 12.5x12.5 | 3-9 | ø28x2 | PA9T | M2.5 |
| BCH1020-A | 13.5x13.5 | 3-11.5 | ø28x2 | PA9T | M2.5 |
| CHL020-A | 13.5x13.5 | 3-11.5 | ø28x2 | PA9T | M2.5 |
| CHL020-P | 13.5x13.5 | 3-11.5 | ø25.3x2.0 | PC | M2.5 |
| H121313E-01 | 13.5x13.5 | 3-11 | ø35x4.3 | PC | M2.5 |
| H121414E-01 | 13.5x13.5 | 3-12 | ø27x4.0 | PC | M2.5 |
| H111512C-02 | 15x12 | 3-11 | ø28x2 | PA9T | M2.5 |
| H111512D-01 | 15x12 | 3-11 | ø25x3.2 | PC | M2.5 |
| SHHMINI-P | 15x12 | 3-10 | ø25.6x2.0 | PC | M2.5 |
| BRHV010-C | 15.8x15.8 | 3-12 | ø28x2 | PA9T | M2.5 |
| BRHV010-P | 15.8x15.8 | 3-12 | ø28x3.5 | PC | M2.5 |
| CRH1507-P | 15.85x15.85 | 3-11 | ø26.9x2.0 | PC | M2.5 |
| H111616A-01 | 15.85x15.85 | 3-11 | ø27.5x4.0 | PC | M2.5 |
| H111616B-01 | 15.85x15.85 | 3-11 | ø27.5x4.0 | PC | M2.5 |
| H111616C-01 | 15.85x15.85 | 3-11 | ø25x4.0 | PC | M2.5 |
| H121616B-01 | 15.85x15.85 | 3-12 | ø27x3.5 | PC | M2.5 |
| NHN036-P | 19x16 | 3-11 | ø30.2x3.0 | PC | M2.5 |
| NHN066-P | 19x16 | 3-11 | ø30.2x3.0 | PC | M2.5 |
| PHI1203-P | 19x16 | 3-11 | ø30.2x3.2 | PC | M2.5 |

CR033-C1C

| Model型号 | FWHM Angle角度 | Lens透镜 | Coverg灯盖 |
|-------------|--------------|--------|-------------------------|
| CR03318-C1C | 18° | - | Transparent Atomization |
| CR03340-C1C | 40° | - | Atomization |
| CR03360-C1C | 60° | - | Atomization |

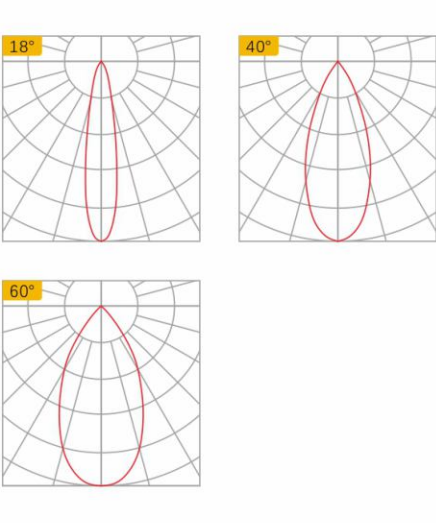

P.12 | Reflector

光源/SOURCE / LES 4~9mm

| | |
|-----------|---|
| Bridgelux | E6 / E8 / E6 CA / V6 gen8- gen9 / V4 HD- gen7- gen8 / V6 HD- gen7- gen8 |
| Citizen | CLU7B2 / CLU7A2 / CLU7A3 / CLU703 / CLU702 / CLU701 |
| CREE | CXB1304 / CXB1310 / CMA1303 / CMA1306 / CMB1304 / CMB1306 / CHA0410 / CHA0612 |
| Lumileds | L02x06 |

| | |
|----------|---|
| Luminus | CXM-3 gen4 / CXM-4 gen4 / CXM-4 gen6 / CHM-4-BH40 / CXM-4-TE50 LUX / CXM-6-AC30 gen3 / CXM-6 gen4 / CXM-6 gen6 / CHM-6-BH40 / CXM-6 LUX |
| Nichia | NVNW5007Z |
| Tridonic | SLE 04mm / SLE 06mm |
| Samsung | LC010C |
| Seoul | SAWS0661A |

支架/HOLDERS

| Type | COB size(mm) | COB LES(mm) | Size(mm) | Material | Screw size |
|-------------|--------------|-------------|---------------|----------|------------|
| BRHV068-PA | 12.5x12.5 | 3-9 | 20x20x3.8 | PC | M2.5 |
| BRHV068-F | 12.5x12.5 | 3-9 | ø28x2 | PA9T | M2.5 |
| H101313A-01 | 12.5x12.5 | 3-9 | ø25x3.5 | PC | M2.5 |
| BCH1020-A | 13.5x13.5 | 3-11.5 | ø28x2 | PA9T | M2.5 |
| CHL020-A | 13.5x13.5 | 3-11.5 | ø28x2 | PA9T | M2.5 |
| CHL020-P | 13.5x13.5 | 3-11.5 | ø25.3x2.0 | PC | M2.5 |
| H121414E-01 | 13.5x13.5 | 3-12 | ø27x4.0 | PC | M2.5 |
| H081313E-01 | 13.35x13.35 | 3-8 | 20.2x20.2x5.0 | PC | M2.5 |
| H101512E-01 | 15x12 | 3-9 | ø25x3.2 | PC | M2.5 |
| H111512C-02 | 15x12 | 3-11 | ø28x2 | PA9T | M2.5 |
| H111512D-01 | 15x12 | 3-11 | ø25x3.2 | PC | M2.5 |
| SHHMINI-P | 15x12 | 3-10 | ø25.6x2.0 | PC | M2.5 |
| BRHV010-C | 15.8x15.8 | 3-12 | ø28x2 | PA9T | M2.5 |
| BRHV010-P | 15.8x15.8 | 3-12 | ø28x3.5 | PC | M2.5 |

R035AC-10

| Model型号 | FWHM Angle角度 | Lens透镜 | Coverg灯盖 |
|-------------|--------------|--------|-------------|
| R03524AC-10 | 24° | - | Atomization |
| R03538AC-10 | 38° | - | Atomization |
| R03556AC-10 | 56° | - | Atomization |

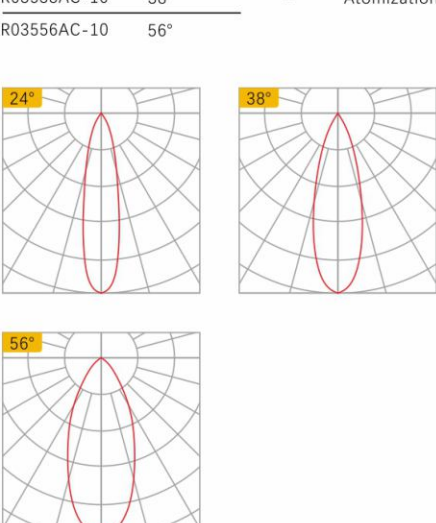

P.13 | Reflector

光源/SOURCE / LES 4~8mm

| | |
|-----------|---|
| Bridgelux | E6 / E6 CA / V6 gen8- gen9 / V4 HD- gen7- gen8 |
| Citizen | CLU7B2 / CLU7A2 / CLU7A3 / CLU703 / CLU702 / CLU701 |
| CREE | CXB1304 / CXB1310 / CMA1303 / CMA1306 / CMB1304 / CMB1306 / CHA0304 / CHA0410 / CHA0612 |
| Lumileds | L02x06 |

| | |
|----------|---|
| Luminus | CXM-3 gen4 / CXM-4 gen4 / CXM-4 gen6 / CHM-4-BH40 / CXM-4-TE50 LUX / CXM-6-AC30 gen3 / CXM-6 gen4 / CXM-6 gen6 / CHM-6-BH40 / CXM-6 LUX |
| Nichia | NVNW5007Z |
| Tridonic | SLE 04mm / SLE 06mm |
| Samsung | LC010C |
| Seoul | SAWS0661A |

支架/HOLDERS

| Type | COB size(mm) | COB LES(mm) | Size(mm) | Material | Screw size |
|-------------|--------------|-------------|---------------|----------|------------|
| BRHV068-F | 12.5x12.5 | 3-9 | ø28x2 | PA9T | M2.5 |
| BRHV068-PA | 12.5x12.5 | 3-9 | 20x20x3.8 | PC | M2.5 |
| BRHV068-PD | 12.5x12.5 | 3-9 | 25.6x23.2x3.7 | PC | M2.5 |
| H101313A-01 | 12.5x12.5 | 3-9 | ø25x3.5 | PC | M2.5 |
| BCH1020-A | 13.5x13.5 | 3-11.5 | ø28x2 | PA9T | M2.5 |
| CHL020-A | 13.5x13.5 | 3-11.5 | ø28x2 | PA9T | M2.5 |
| CHL020-P | 13.5x13.5 | 3-11.5 | ø25.3x2.0 | PC | M2.5 |
| H121414E-01 | 13.5x13.5 | 3-12 | ø27x4.0 | PC | M2.5 |
| H081313E-01 | 13.35x13.35 | 3-8 | ø25x3.6 | PC | M2.5 |
| H111512C-02 | 15x12 | 3-11 | ø28x2 | PA9T | M2.5 |
| H111512D-01 | 15x12 | 3-11 | ø25x3.2 | PC | M2.5 |
| H101512E-01 | 15x12 | 3-9 | ø25x3.2 | PC | M2.5 |
| SHHMINI-P | 15x12 | 3-10 | ø25.6x2.0 | PC | M2.5 |
| BRHV010-C | 15.8x15.8 | 3-12 | ø28x2 | PA9T | M2.5 |
| BRHV010-P | 15.8x15.8 | 3-12 | ø28x3.5 | PC | M2.5 |



R035CC-10

| Model型号 | FWHM Angle角度 | Lens透镜 | Coverg灯盖 |
|-------------|--------------|--------|-------------|
| R03526CC-10 | 26° | | |
| R03542CC-10 | 42° | - | Atomization |
| R03560CC-10 | 60° | | |

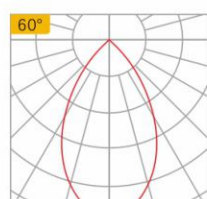
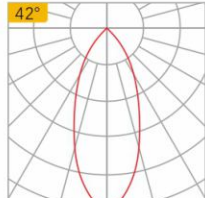
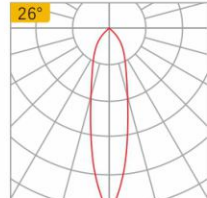

P.14 | Reflector

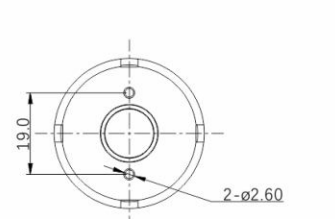
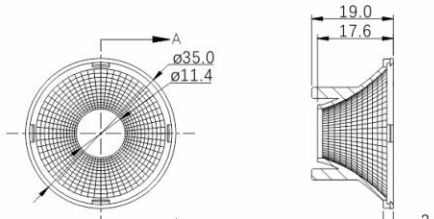

■光源/SOURCE / LES 8-12mm

| BridgeLux | V10 gen7 / E8 CA / E10 / V10 gen7-gen8-gen9 |
|-----------|---|
| Citizen | CLU028 / CLU021 / CLU02Q / CLU703 / CLU702 / CLU701 |
| CREE | CHA0612 / CMA1516 / CMB1507 / CMB1510 / CMB1516 / CMT1407 / CMT1412 / CMT1420 / CMU1003 / CMU1006 / CMU1010 / CMU1013 / CXB1507 / CXB1512 / CXB1520 |
| Lumens | ERC1507HO / ERC1512HO / 1309H2 / 1318H2 |
| Lumileds | 1202s / L02x09 / L04x09 / S04H9 / M02F09 / M03F09 |

| Luminus | CXM-6-AC30 gen3 / CXM-6 gen6 / CHM-6-BH40 / CXM-6 LUX / CHM-9 gen3 / CIM-9 gen4 / CLM-9-AC40 gen4 / CXM-9-AC40 gen4 / CLM-9 gen6 / CXM-9-TC60 gen6 |
|----------|--|
| Osram | S9 |
| Nichia | NFCWS024B / NJCWS024Z / NFCWL036B / NVEWL016Z |
| Tridonic | SLE 06mm / SLE 09mm |
| Samsung | LC003D / LC006D / LC009D / LC013D |
| Seoul | SAWS1063A |

■支架/HOLDERS

| Type | COB size(mm) | COB LES(mm) | Size(mm) | Material | Screw size |
|-------------|--------------|-------------|-----------|----------|------------|
| BRHV068-F | 12.5x12.5 | 3-9 | ø28x2 | PA9T | M2.5 |
| BCH1020-A | 13.5x13.5 | 3-11.5 | ø28x2 | PA9T | M2.5 |
| CIHL020-A | 13.5x13.5 | 3-11.5 | ø28x2 | PA9T | M2.5 |
| CIHL020-P | 13.5x13.5 | 3-11.5 | ø25.3x2.0 | PC | M2.5 |
| H121313E-01 | 13.5x13.5 | 3-11 | ø35x4.3 | PC | M2.5 |
| H121414E-01 | 13.5x13.5 | 3-12 | ø27x4.0 | PC | M2.5 |
| H111512C-02 | 15x12 | 3-11 | ø28x2 | PA9T | M2.5 |
| H111512D-01 | 15x12 | 3-11 | ø25x3.2 | PC | M2.5 |
| SHHMINI-P | 15x12 | 3-10 | ø25.6x2.0 | PC | M2.5 |
| BRHV010-C | 15.8x15.8 | 3-12 | ø28x2 | PA9T | M2.5 |
| BRHV010-P | 15.8x15.8 | 3-12 | ø28x3.5 | PC | M2.5 |
| CRH1507-P | 15.85x15.85 | 3-11 | ø26.9x2.0 | PC | M2.5 |
| H111616A-01 | 15.85x15.85 | 3-11 | ø27.5x4.0 | PC | M2.5 |
| H111616B-01 | 15.85x15.85 | 3-11 | ø27.5x4.0 | PC | M2.5 |
| H111616C-01 | 15.85x15.85 | 3-11 | ø25x4.0 | PC | M2.5 |
| H121616B-01 | 15.85x15.85 | 3-12 | ø27x3.5 | PC | M2.5 |
| NHNN036-P | 19x16 | 3-11 | ø30.2x3.0 | PC | M2.5 |
| NHNN066-P | 19x16 | 3-11 | ø30.2x3.0 | PC | M2.5 |
| PIH1203-P | 19x16 | 3-11 | ø30.2x3.2 | PC | M2.5 |



BR040-C1C

| Model型号 | FWHM Angle角度 | Lens透镜 | Coverg灯盖 |
|-------------|--------------|--------|-------------------------|
| BR04024-C1C | 24° | | |
| BR04038-C1C | 38° | - | Transparent Atomization |
| BR04058-C1C | 58° | | |

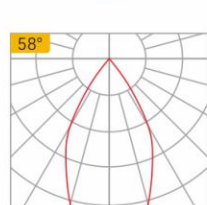
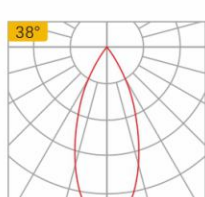
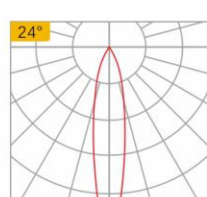

P.15 | Reflector

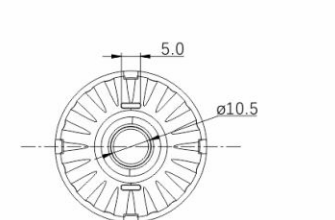
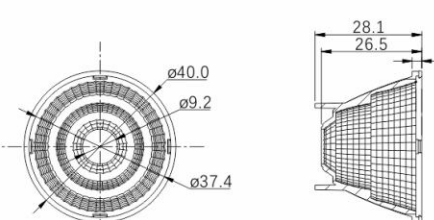

■光源/SOURCE / LES 4-9mm

| BridgeLux | E6 / E8 / E6 CA / V6 gen8-gen9 / V8 gen7-gen8-gen9 / V4 HD gen7-gen8 / V6 HD gen7-gen8 |
|-----------|--|
| Citizen | CLU7A2 / CLU7A3 / CLU703 / CLU702 / CLU701 |
| CREE | CXB1304 / CXB1310 / CMA1303 / CMA1306 / CMB1304 / CMB1306 / CHA0410 / CHA0612 |
| Lumileds | L02x06 |

| Luminus | CXM-3 gen4 / CXM-4 gen4 / CXM-4 gen6 / CHM-6-BH40 / CXM-6 LUX / CHM-9 gen3 / CXM-6-AC30 gen3 / CXM-6 gen4 / CXM-6 gen6 / CHM-6-BH40 / CXM-6 LUX |
|----------|---|
| Nichia | NVNWS007Z |
| Tridonic | SLE 04mm / SLE 06mm |
| Samsung | LC010C |
| Seoul | SAWS0661A |

■支架/HOLDERS

| Type | COB size(mm) | COB LES(mm) | Size(mm) | Material | Screw size |
|-------------|--------------|-------------|---------------|----------|------------|
| BRHV068-F | 12.5x12.5 | 3-9 | ø28x2 | PA9T | M2.5 |
| BRHV068-PA | 12.5x12.5 | 3-9 | 20x20x3.8 | PC | M2.5 |
| BRHV068-PD | 12.5x12.5 | 3-9 | 25.6x23.2x3.7 | PC | M2.5 |
| H101313A-01 | 12.5x12.5 | 3-9 | ø25x3.5 | PC | M2.5 |
| BCH1020-A | 13.5x13.5 | 3-11.5 | ø28x2 | PA9T | M2.5 |
| H121414E-01 | 13.5x13.5 | 3-12 | ø27x4.0 | PC | M2.5 |
| CRH1304-P | 13.35x13.35 | 3-9 | 20.2x20.2x5.0 | PC | M2.5 |
| H081313E-01 | 13.35x13.35 | 3-8 | ø25x3.6 | PC | M2.5 |
| H111512C-02 | 15x12 | 3-11 | ø28x2 | PA9T | M2.5 |
| H111512D-01 | 15x12 | 3-11 | ø25x3.2 | PC | M2.5 |
| H101512E-01 | 15x12 | 3-9 | ø25x3.2 | PC | M2.5 |
| BRHV010-C | 15.8x15.8 | 3-12 | ø28x2 | PA9T | M2.5 |
| BRHV010-P | 15.8x15.8 | 3-12 | ø28x3.5 | PC | M2.5 |



BR040-C1N

| Model型号 | FWHM Angle角度 | Lens透镜 | Coverg灯盖 |
|-------------|--------------|--------|----------|
| BR04025-C1N | 25° | - | - |
| BR04040-C1N | 40° | | |
| BR04060-C1N | 60° | | |

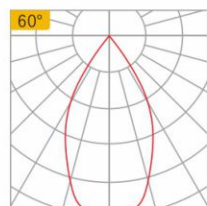
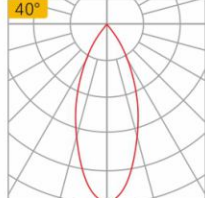
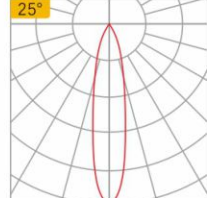

P.16 | Reflector

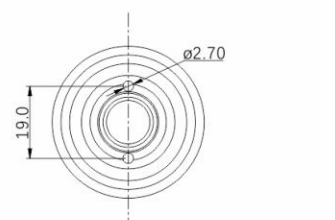
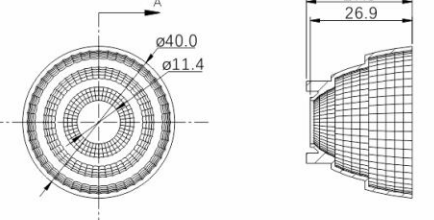

■光源/SOURCE / LES 8-12mm

| BridgeLux | V10 / E8 CA / E10 / V10 gen7-gen8-gen9 |
|-----------|---|
| Citizen | CLU028 / CLU021 / CLU02Q / CLU703 / CLU702 / CLU701 |
| CREE | CHA0612 / CMA1516 / CMB1507 / CMB1510 / CMB1516 / CMT1407 / CMT1412 / CMT1420 / CMU1003 / CMU1006 / CMU1010 / CMU1013 / CXB1507 / CXB1512 / CXB1520 |
| Lumens | ERC1507HO / ERC1512HO / 1309H2 / 1318H2 |
| Lumileds | 1202s / L02x09 / L04x09 / S04H9 / M02F09 / M03F09 |

| Luminus | CXM-6-AC30 gen3 / CXM-6 gen6 / CHM-6-BH40 / CXM-6 LUX / CHM-9 gen3 / CIM-9 gen4 / CLM-9-AC40 gen4 / CXM-9-AC40 gen4 / CLM-9 gen6 / CXM-9-TC60 gen6 |
|----------|--|
| Osram | S9 |
| Nichia | NFCWS024B / NJCWS024Z / NFCWL036B / NVEWL016Z |
| Tridonic | SLE 06mm / SLE 09mm |
| Samsung | LC003D / LC006D / LC009D / LC013D |
| Samsung | SAWS1063A |

■支架/HOLDERS

| Type | COB size(mm) | COB LES(mm) | Size(mm) | Material | Screw size |
|-------------|--------------|-------------|-----------|----------|------------|
| BRHV068-F | 12.5x12.5 | 3-9 | ø28x2 | PA9T | M2.5 |
| BCH1020-A | 13.5x13.5 | 3-11.5 | ø28x2 | PA9T | M2.5 |
| CIHL020-A | 13.5x13.5 | 3-11.5 | ø28x2 | PA9T | M2.5 |
| CIHL020-P | 13.5x13.5 | 3-11.5 | ø25.3x2.0 | PC | M2.5 |
| H121313E-01 | 13.5x13.5 | 3-11 | ø35x4.3 | PC | M2.5 |
| H121414E-01 | 13.5x13.5 | 3-12 | ø27x4.0 | PC | M2.5 |
| H111512C-02 | 15x12 | 3-11 | ø28x2 | PA9T | M2.5 |
| H111512D-01 | 15x12 | 3-11 | ø25x3.2 | PC | M2.5 |
| SHHMINI-P | 15x12 | 3-10 | ø25.6x2.0 | PC | M2.5 |
| BRHV010-C | 15.8x15.8 | 3-12 | ø28x2 | PA9T | M2.5 |
| BRHV010-P | 15.8x15.8 | 3-12 | ø28x3.5 | PC | M2.5 |
| CRH1507-P | 15.85x15.85 | 3-11 | ø26.9x2.0 | PC | M2.5 |
| H111616A-01 | 15.85x15.85 | 3-11 | ø27.5x4.0 | PC | M2.5 |
| H111616B-01 | 15.85x15.85 | 3-11 | ø27.5x4.0 | PC | M2.5 |
| H111616C-01 | 15.85x15.85 | 3-11 | ø25x4.0 | PC | M2.5 |
| H121616B-01 | 15.85x15.85 | 3-12 | ø27x3.5 | PC | M2.5 |
| NHNN036-P | 19x16 | 3-11 | ø30.2x3.0 | PC | M2.5 |
| NHNN066-P | 19x16 | 3-11 | ø30.2x3.0 | PC | M2.5 |
| PIH1203-P | 19x16 | 3-11 | ø30.2x3.2 | PC | M2.5 |



QR041-C1N

| Model型号 | FWHM Angle角度 | Lens透镜 | Coverg灯盖 |
|-------------|--------------|--------|----------|
| QR04120-C1N | 20° | - | - |
| QR04130-C1N | 30° | | |
| QR04138-C1N | 38° | | |

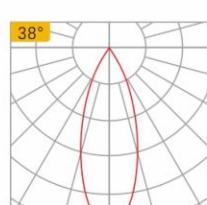
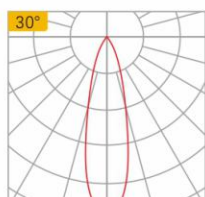
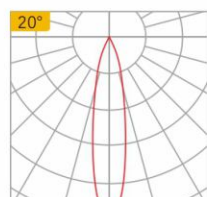

P.17 | Reflector

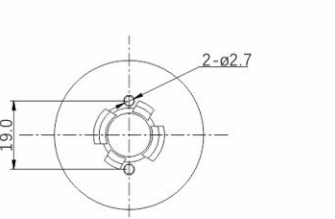
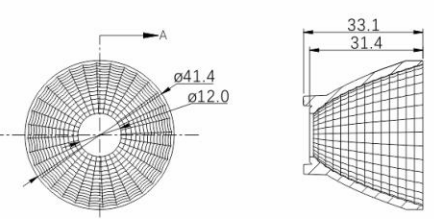

■光源/SOURCE / LES 8-12mm

| BridgeLux | E8 CA / E10 / V10 gen7-gen8-gen9 |
|-----------|---|
| Citizen | CLU028 / CLU021 / CLU02Q / CLU703 / CLU702 / CLU701 |
| CREE | CHA0612 / CMA1516 / CMB1507 / CMB1510 / CMB1516 / CMT1407 / CMT1412 / CMT1420 / CMU1003 / CMU1006 / CMU1010 / CMU1013 / CXB1507 / CXB1512 / CXB1520 |
| Lumens | ERC1507HO / ERC1512HO / 1309H2 / 1318H2 |
| Lumileds | 1202s / L02x09 / L04x09 / S04H9 / M02F09 / M03F09 |

| Luminus | CXM-6-AC30 gen3 / CXM-6 gen6 / CHM-6-BH40 / CXM-6 LUX / CHM-9 gen3 / CIM-9 gen4 / CLM-9-AC40 gen4 / CXM-9-AC40 gen4 / CLM-9 gen6 / CXM-9-TC60 gen6 |
|----------|--|
| Osram | S9 |
| Nichia | NFCWS024B / NJCWS024Z / NFCWL036B / NVEWL016Z |
| Tridonic | SLE 06mm / SLE 09mm |
| Samsung | LC003D / LC006D / LC009D / LC013D |
| Seoul | SAWS1063A |

■支架/HOLDERS

| Type | COB size(mm) | COB LES(mm) | Size(mm) | Material | Screw size |
|-------------|--------------|-------------|-----------|----------|------------|
| BRHV068-F | 12.5x12.5 | 3-9 | ø28x2 | PA9T | M2.5 |
| BCH1020-A | 13.5x13.5 | 3-11.5 | ø28x2 | PA9T | M2.5 |
| CIHL020-A | 13.5x13.5 | 3-11.5 | ø28x2 | PA9T | M2.5 |
| CIHL020-P | 13.5x13.5 | 3-11.5 | ø25.3x2.0 | PC | M2.5 |
| H121313E-01 | 13.5x13.5 | 3-11 | ø35x4.3 | PC | M2.5 |
| H121414E-01 | 13.5x13.5 | 3-12 | ø27x4.0 | PC | M2.5 |
| H111512C-02 | 15x12 | 3-11 | ø28x2 | PA9T | M2.5 |
| H111512D-01 | 15x12 | 3-11 | ø25x3.2 | PC | M2.5 |
| SHHMINI-P | 15x12 | 3-10 | ø25.6x2.0 | PC | M2.5 |
| BRHV010-C | 15.8x15.8 | 3-12 | ø28x2 | PA9T | M2.5 |
| BRHV010-P | 15.8x15.8 | 3-12 | ø28x3.5 | PC | M2.5 |
| CRH1507-P | 15.85x15.85 | 3-11 | ø26.9x2.0 | PC | M2.5 |
| H111616A-01 | 15.85x15.85 | 3-11 | ø27.5x4.0 | PC | M2.5 |
| H111616B-01 | 15.85x15.85 | 3-11 | ø27.5x4.0 | PC | M2.5 |
| H111616C-01 | 15.85x15.85 | 3-11 | ø25x4.0 | PC | M2.5 |
| H121616B-01 | 15.85x15.85 | 3-12 | ø27x3.5 | PC | M2.5 |
| NHNN036-P | 19x16 | 3-11 | ø30.2x3.0 | PC | M2.5 |
| NHNN066-P | 19x16 | 3-11 | ø30.2x3.0 | PC | M2.5 |
| PIH1203-P | 19x16 | 3-11 | ø30.2x3.2 | PC | M2.5 |



BR044-C1C

| Model型号 | FWHM Angle角度 | Lens透镜 | Coverg灯盖 |
|-------------|--------------|--------|-------------------------|
| BR04415-C1C | 15° | - | - |
| BR04428-C1C | 28° | - | Transparent Atomization |
| BR04440-C1C | 40° | | |
| BR04460-C1C | 60° | | |

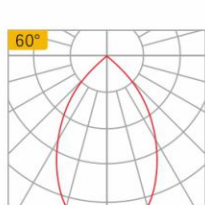
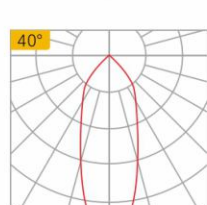
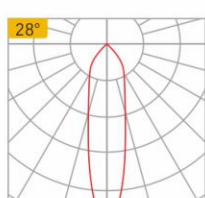
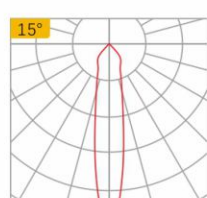

P.18 | Reflector

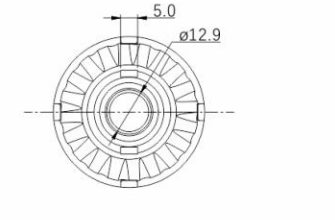
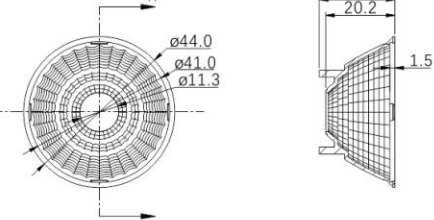

■光源/SOURCE / LES 7-12mm

| BridgeLux | V8 gen7 / V10 gen7 / E8 CA / E6 / E10 / V6 HD gen7-gen8 / V10 gen7-gen8-gen9 / Vero10 |
|-----------|---|
|-----------|---|

■支架/HOLDERS

| Type | COB size(mm) | COB LES(mm) | Size(mm) | Material | Screw size |
|-------------|--------------|-------------|-----------|----------|------------|
| BRHV068-F | 12.5x12.5 | 3-9 | ø28x2 | PA9T | M2.5 |
| BCH1020-A | 13.5x13.5 | 3-11.5 | ø28x2 | PA9T | M2.5 |
| CIHL020-A | 13.5x13.5 | 3-11.5 | ø28x2 | PA9T | M2.5 |
| CIHL020-P | 13.5x13.5 | 3-11.5 | ø25.3x2.0 | PC | M2.5 |
| H121313E-01 | 13.5x13.5 | 3-11 | | | |



QR044-C1C

Model型号 FWHM Angle角度 Lens透镜 Cover灯盖

| | | | |
|-------------|-----|---|-------------------------|
| QR04415-C1C | 15° | - | Transparent Atomization |
| QR04428-C1C | 28° | | |
| QR04440-C1C | 40° | | |
| QR04460-C1C | 60° | | |

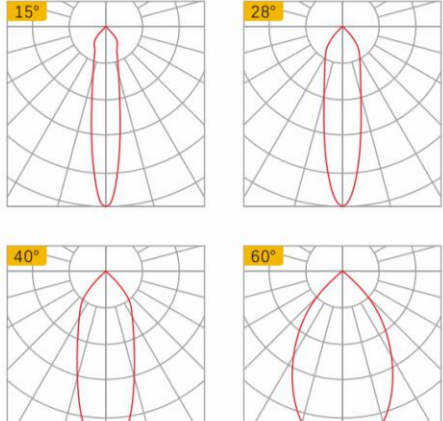

P.21 | Reflector

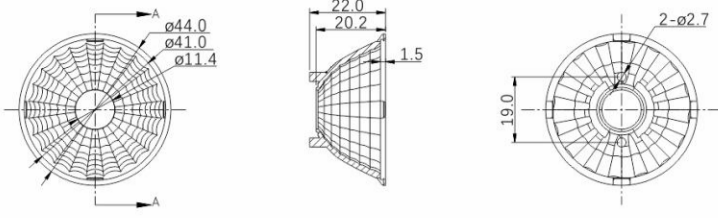

光源/SOURCE / LES 8~12mm

| | |
|-----------|--|
| Bridgelux | V10 gen7 / E8 CA / E10 / V10 gen7-gen8-gen9 CLU028 / CLU021 / CLU02Q / CLU703 |
| Citizen | CLU028 / CLU021 / CLU02Q / CLU703 |
| CREE | CHA0612 / CMA1516 / CMB1507 / CMB1510 CMB1516 / CMT1407 / CMT1412 / CMT1420 CMU1003 / CMU1006 / CMU1010 / CMU1013 CXB1507 / CXB1512 / CXB1520 |
| Lumens | ERC1507HO / ERC1512HO / 1309H2 / 1318H2 |
| Lumileds | 1202s / L02x09 / L04x09 / S04H9 / M02F09 / M03F09 |

| | |
|----------|--|
| Luminus | CXM-6-AC30 gen3 / CXM-6 gen6 CHM-6-BH40 / CXM-6 LUX CHM-9 gen3 / CIM-9 gen4 CLM-9-AC40 gen4 / CXM-9-AC40 gen4 CLM-9 gen6 / CXM-9-TC60 gen6 |
| Osram | S9 |
| Nichia | NFCWS024B / NJCWS024Z / NFCWL036B / NVEWL016Z |
| Tridonic | SLE 06mm / SLE 09mm |
| Samsung | LC003D / LC006D / LC009D / LC013D |
| Samsung | SAWS1063A |

支架/HOLDERS

| Type | COB size(mm) | COB LES(mm) | Size(mm) | Material | Screw size |
|-------------|--------------|-------------|-----------|----------|------------|
| BRHV068-F | 12.5x12.5 | 3-9 | ø28x2 | PA9T | M2.5 |
| BCH1020-A | 13.5x13.5 | 3-11.5 | ø28x2 | PA9T | M2.5 |
| CHL020-P | 13.5x13.5 | 3-11.5 | ø28x2 | PA9T | M2.5 |
| CHL020-A | 13.5x13.5 | 3-11.5 | ø25.3x2.0 | PC | M2.5 |
| H121313E-01 | 13.5x13.5 | 3-11 | ø35x4.3 | PC | M2.5 |
| H121414E-01 | 13.5x13.5 | 3-12 | ø27x4.0 | PC | M2.5 |
| H111512C-02 | 15x12 | 3-11 | ø28x2 | PA9T | M2.5 |
| H111512D-01 | 15x12 | 3-11 | ø25x3.2 | PC | M2.5 |
| SHHMINI-P | 15x12 | 3-10 | ø25.6x2.0 | PC | M2.5 |
| BRHV010-C | 15.8x15.8 | 3-12 | ø28x2 | PA9T | M2.5 |
| BRHV010-P | 15.8x15.8 | 3-12 | ø28x3.5 | PC | M2.5 |
| CRH1507-P | 15.85x15.85 | 3-11 | ø26.9x2.0 | PC | M2.5 |
| H111616A-01 | 15.85x15.85 | 3-11.5 | ø27.5x4.0 | PC | M2.5 |
| H111616B-01 | 15.85x15.85 | 3-11.5 | ø27.5x4.0 | PC | M2.5 |
| H111616C-01 | 15.85x15.85 | 3-11.5 | ø25x4.0 | PC | M2.5 |
| H121616B-01 | 15.85x15.85 | 3-12 | ø27x3.5 | PC | M2.5 |
| NHNN036-P | 19x16 | 3-11 | ø30.2x3.0 | PC | M2.5 |
| NHNN066-P | 19x16 | 3-11 | ø30.2x3.0 | PC | M2.5 |
| PIH1203-P | 19x16 | 3-11 | ø30.2x3.2 | PC | M2.5 |

QR044-C1N

Model型号 FWHM Angle角度 Lens透镜 Cover灯盖

| | | | |
|-------------|-----|---|---|
| QR04420-C1N | 20° | - | - |
| QR04430-C1N | 30° | | |
| QR04438-C1N | 38° | | |

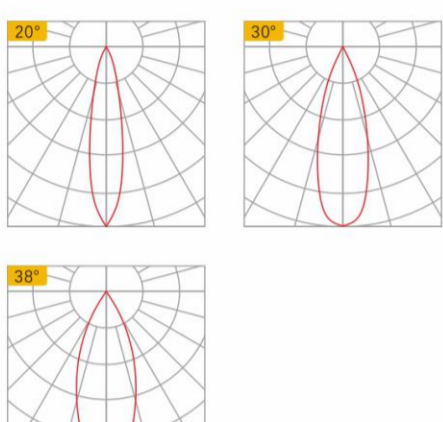

P.22 | Reflector

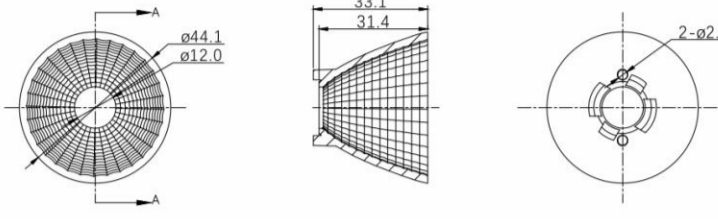

光源/SOURCE / LES 8~12mm

| | |
|-----------|--|
| Bridgelux | V10 gen7 / E8 CA / E10 / V10 gen7-gen8-gen9 CLU028 / CLU021 / CLU02Q / CLU703 |
| Citizen | CLU028 / CLU021 / CLU02Q / CLU703 |
| CREE | CHA0612 / CMA1516 / CMB1507 / CMB1510 CMB1516 / CMT1407 / CMT1412 / CMT1420 CMU1003 / CMU1006 / CMU1010 / CMU1013 CXB1507 / CXB1512 / CXB1520 |
| Lumens | ERC1507HO / ERC1512HO / 1309H2 / 1318H2 |
| Lumileds | 1202s / L02x09 / L04x09 / S04H9 / M02F09 / M03F09 |

| | |
|----------|--|
| Luminus | CXM-6-AC30 gen3 / CXM-6 gen6 CHM-6-BH40 / CXM-6 LUX CHM-9 gen3 / CIM-9 gen4 CLM-9-AC40 gen4 / CXM-9-AC40 gen4 CLM-9 gen6 / CXM-9-TC60 gen6 |
| Osram | S9 |
| Nichia | NFCWS024B / NJCWS024Z / NFCWL036B / NVEWL016Z |
| Tridonic | SLE 06mm / SLE 09mm |
| Samsung | LC003D / LC006D / LC009D / LC013D |
| Samsung | SAWS1063A |

支架/HOLDERS

| Type | COB size(mm) | COB LES(mm) | Size(mm) | Material | Screw size |
|-------------|--------------|-------------|-----------|----------|------------|
| BRHV068-F | 12.5x12.5 | 3-9 | ø28x2 | PA9T | M2.5 |
| BCH1020-A | 13.5x13.5 | 3-11.5 | ø28x2 | PA9T | M2.5 |
| CHL020-P | 13.5x13.5 | 3-11.5 | ø28x2 | PA9T | M2.5 |
| CHL020-A | 13.5x13.5 | 3-11.5 | ø25.3x2.0 | PC | M2.5 |
| H121313E-01 | 13.5x13.5 | 3-11 | ø35x4.3 | PC | M2.5 |
| H121414E-01 | 13.5x13.5 | 3-12 | ø27x4.0 | PC | M2.5 |
| H111512C-02 | 15x12 | 3-11 | ø28x2 | PA9T | M2.5 |
| H111512D-01 | 15x12 | 3-11 | ø25x3.2 | PC | M2.5 |
| SHHMINI-P | 15x12 | 3-10 | ø25.6x2.0 | PC | M2.5 |
| BRHV010-C | 15.8x15.8 | 3-12 | ø28x2 | PA9T | M2.5 |
| BRHV010-P | 15.8x15.8 | 3-12 | ø28x3.5 | PC | M2.5 |
| CRH1507-P | 15.85x15.85 | 3-11 | ø26.9x2.0 | PC | M2.5 |
| H111616A-01 | 15.85x15.85 | 3-11 | ø27.5x4.0 | PC | M2.5 |
| H111616B-01 | 15.85x15.85 | 3-11 | ø27.5x4.0 | PC | M2.5 |
| H111616C-01 | 15.85x15.85 | 3-11 | ø25x4.0 | PC | M2.5 |
| H121616B-01 | 15.85x15.85 | 3-12 | ø27x3.5 | PC | M2.5 |
| NHNN036-P | 19x16 | 3-11 | ø30.2x3.0 | PC | M2.5 |
| NHNN066-P | 19x16 | 3-11 | ø30.2x3.0 | PC | M2.5 |
| PIH1203-P | 19x16 | 3-11 | ø30.2x3.2 | PC | M2.5 |

BR050-C1C

Model型号 FWHM Angle角度 Lens透镜 Cover灯盖

| | | | |
|-------------|-----|---|-------------------------|
| BR05021-C1C | 21° | - | Transparent Atomization |
| BR05041-C1C | 41° | | |
| BR05061-C1C | 61° | | |

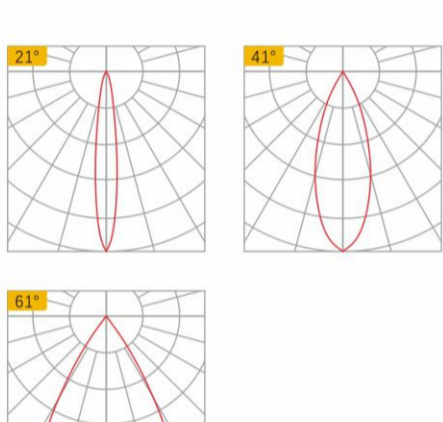

P.23 | Reflector

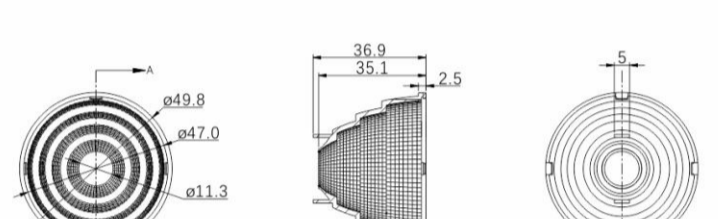

光源/SOURCE / LES 8~12mm

| | |
|-----------|--|
| Bridgelux | V10 / E8 CA / E10 / V10 gen7-gen8-gen9 CLU028 / CLU021 / CLU02Q / CLU703 |
| Citizen | CLU028 / CLU021 / CLU02Q / CLU703 |
| CREE | CHA0612 / CMA1516 / CMB1507 / CMB1510 CMB1516 / CMT1407 / CMT1412 / CMT1420 CMU1003 / CMU1006 / CMU1010 / CMU1013 CXB1507 / CXB1512 / CXB1520 |
| Lumens | ERC1507HO / ERC1512HO / 1309H2 / 1318H2 |
| Lumileds | 1202s / L02x09 / L04x09 / S04H9 / M02F09 / M03F09 |

| | |
|----------|---|
| Luminus | CXM-6-AC30 gen3 / CXM-6 gen6 CHM-6-BH40 / CXM-6 LUX / CHM-9 gen3 CIM-9 gen4 / CLM-9-AC40 gen4 CLM-9 gen6 / CXM-9-TC60 gen6 |
| Osram | S9 |
| Nichia | NFCWS024B / NJCWS024Z / NFCWL036B / NVEWL016Z |
| Tridonic | SLE 06mm / SLE 09mm |
| Samsung | LC003D / LC006D / LC009D / LC013D |
| Samsung | SAWS1063A |

支架/HOLDERS

| Type | COB size(mm) | COB LES(mm) | Size(mm) | Material | Screw size |
|-------------|--------------|-------------|-----------|----------|------------|
| BRHV068-F | 12.5x12.5 | 3-9 | ø28x2 | PA9T | M2.5 |
| BCH1020-A | 13.5x13.5 | 3-11.5 | ø28x2 | PA9T | M2.5 |
| CHL020-P | 13.5x13.5 | 3-11.5 | ø28x2 | PA9T | M2.5 |
| CHL020-A | 13.5x13.5 | 3-11.5 | ø25.3x2.0 | PC | M2.5 |
| H121313E-01 | 13.5x13.5 | 3-11 | ø35x4.3 | PC | M2.5 |
| H121414E-01 | 13.5x13.5 | 3-12 | ø27x4.0 | PC | M2.5 |
| H111512C-02 | 15x12 | 3-11 | ø28x2 | PA9T | M2.5 |
| H111512D-01 | 15x12 | 3-11 | ø25x3.2 | PC | M2.5 |
| SHHMINI-P | 15x12 | 3-10 | ø25.6x2.0 | PC | M2.5 |
| BRHV010-C | 15.8x15.8 | 3-12 | ø28x2 | PA9T | M2.5 |
| BRHV010-P | 15.8x15.8 | 3-12 | ø28x3.5 | PC | M2.5 |
| CRH1507-P | 15.85x15.85 | 3-11 | ø26.9x2.0 | PC | M2.5 |
| H111616A-01 | 15.85x15.85 | 3-11 | ø27.5x4.0 | PC | M2.5 |
| H111616B-01 | 15.85x15.85 | 3-11 | ø27.5x4.0 | PC | M2.5 |
| H111616C-01 | 15.85x15.85 | 3-11 | ø25x4.0 | PC | M2.5 |
| H121616B-01 | 15.85x15.85 | 3-12 | ø27x3.5 | PC | M2.5 |
| NHNN036-P | 19x16 | 3-11 | ø30.2x3.0 | PC | M2.5 |
| NHNN066-P | 19x16 | 3-11 | ø30.2x3.0 | PC | M2.5 |
| PIH1203-P | 19x16 | 3-11 | ø30.2x3.2 | PC | M2.5 |

BR050-BV13

Model型号 FWHM Angle角度 Lens透镜 Cover灯盖

| | | | |
|-------------|-----|---|-------------------------|
| BR05024-C1C | 24° | - | Transparent Atomization |
| BR05040-C1C | 40° | | |
| BR05060-C1C | 60° | | |

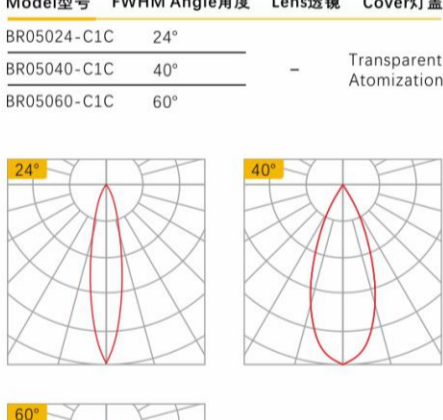

P.24 | Reflector

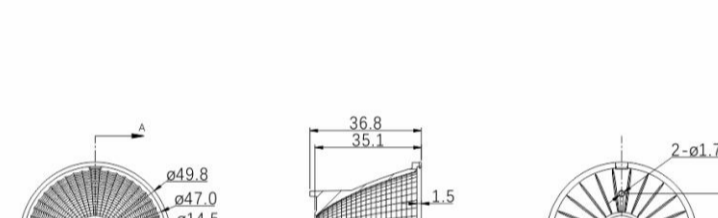

光源/SOURCE / LES 10~14mm

| | |
|-----------|---|
| Bridgelux | E8 CA / V13 gen7 / V9 HD gen7-gen8 V11 HD gen8 / Ver013 |
| Citizen | CLU723 / CLU721 |
| CREE | CXB1816 / CXB1820 / CHA0825 / CMA1516 CMA1825 / CMB1510 / CMB1516 / CMB1818 CMB1825 |
| Lumens | ERC1507HO / ERC1512HO / ERC1812HO ERC1820HO |

| | |
|----------|---|
| Lumileds | 1202 / 1203 / S04H9 / M02F09 / M03F09 / L04F12 / L05F12 |
| Luminus | CHM-9-BH40 / CXM-11 gen3 CXM-11 gen4 / CXM-11 LUX |
| Nichia | NFCWL036B / NVEWL016Z / NFCWL060B / NVCWL024Z |
| Tridonic | SLE 13mm |
| Samsung | LC030C |

支架/HOLDERS

| Type | COB size(mm) | COB LES(mm) | Size(mm) | Material | Screw size |
|-------------|--------------|-------------|---------------|----------|------------|
| BRHV013-A | 15.85x15.85 | 10-14 | ø40x2 | PA9T | M3 |
| BRHV018-P | 15.85x15.85 | 10-15 | ø36.2x4.1 | PC | M2.5 |
| CRH1816-P | 17.85x17.85 | 10-15 | ø36.2x4.1 | PC | M2.5 |
| SAHL013-P | 17x17 | 10-13 | ø37.6x3.7 | PC | M3 |
| BCH1330-A | 19x19 | 10-17 | ø40x2.0 | PA9T | M3 |
| CHL030-A | 19x19 | 10-17 | ø36.2x2 | PA9T | M3 |
| CHL030-P | 19x19 | 10-17 | 29.4x29.4x3.2 | PC | M3 |
| H161919B-01 | 19x19 | 10-16 | ø35x3.5 | PC | M3 |
| BRHV1518-A | 21x21 | 14-19 | ø50x2.0 | PA9T | M3 |
| BRHV015-P | 21x21 | 14-17 | ø36.2x3.0 | PC | M2.5 |
| TRH0017-P | 21x21 | 14-17 | ø36x3.2 | PC | M2.5 |
| SAHC206-P | 21.5x21.5 | 14-18 | ø34x4.4 | PC | M2.5 |
| NHNN216-P | 24x19 | 14-18 | ø36.2x3.0 | PC | M2.5 |
| H182420A-01 | 24x20 | 14-18 | ø35x3.2 | PC | M2.5 |
| PIH1208-P | 24x20 | 14-17 | ø36.2x4.0 | PC | M2.5 |
| SHHMEGA-P | 24x20 | 12-17 | ø35x3.7 | PC | M3 |

BR050-BV18

Model型号 FWHM Angle角度 Lens透镜 Cover灯盖

| | | | |
|-------------|-----|---|-------------------------|
| BR05025-C1C | 25° | - | Transparent Atomization |
| BR05040-C1C | 40° | | |
| BR05060-C1C | 60° | | |

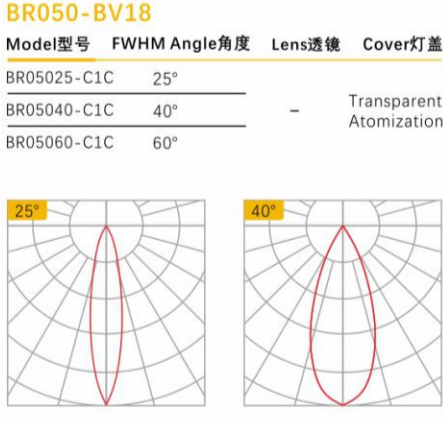

P.25 | Reflector

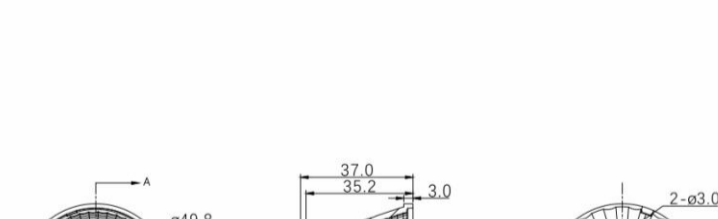

光源/SOURCE / LES 13~18mm

| | |
|-----------|--|
| Bridgelux | E10 / V15 gen7-gen8-gen9 / V9 HD gen7-gen8 V11 HD gen8 / Ver018 |
|-----------|--|

| | |
|---------|--|
| Luminus | CIM-14-AC30 gen3 / CLM-14-AC30 gen3 CXM-14-AC30 gen3 / CIM-14 gen4 CGM-14 gen4 / CXM-14 gen4 CIM-14 gen6 / CLM-14 gen6 / CXM-14 gen6 CLM-14-TC50 LUX |
|---------|--|

支架/HOLDERS

| Type | COB size(mm) | COB LES(mm) | Size(mm) | Material | Screw size |
|-------------|--------------|-------------|---------------|----------|------------|
| CRH1816-P | 17.85x17.85 | 10-15 | ø36.2x4.1 | PC | M2.5 |
| BCH1330-A | 19x19 | 10-17 | ø40x2.0 | PA9T | M3 |
| CHL030-A | 19x19 | 10-17 | ø36.2x2 | PA9T | M3 |
| CHL030-P | 19x19 | 10-17 | 29.4x29.4x3.2 | PC | M3 |
| H161919B-01 | 19x19 | 10-16 | ø35x3.5 | PC | M3 |
| BRHV1518-A | 21x21 | 14-19 | ø50x2.0 | PA9T | M3 |
| BRHV015-P | 21x21 | 14-17 | ø36.2x3.0 | PC | M2.5 |
| TRH0017-P | 21x21 | 14-17 | ø36x3.2 | PC | M2.5 |
| SAHC206-P | 21.5x21.5 | 14-18 | ø34x4.4 | PC | M2.5 |
| NHNN216-P | 24x19 | 14-18 | ø36.2x3.0 | PC | M2.5 |
| H182420A-01 | 24x20 | 14-18 | ø35x3.2 | PC | M2.5 |
| PIH1208-P | 24x20 | 14-17 | ø36.2x4.0 | PC | M2.5 |
| SHHMEGA-P | 24x20 | 12-17 | ø35x3.7 | PC | M3 |

OP050-C1C

Model型号 FWHM Angle角度 Lens透镜 Cover灯盖

| | | | |
|-------------|-----|-----|-------------------------|
| OP05024-C1C | 24° | Yes | Transparent Atomization |
| OP05040-C1C | 40° | | |
| OP05060-C1C | 60° | | |



P.26 | Reflector

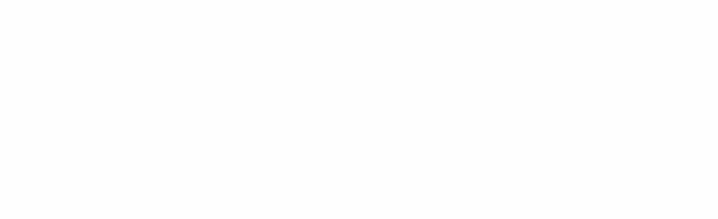

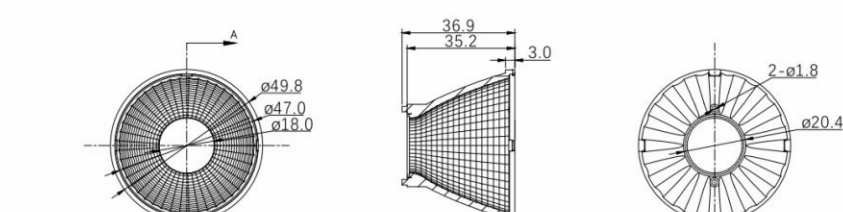

QR050-C1C

| Model型号 | FWHM Angle角度 | Lens透镜 | Cover灯盖 |
|-------------|--------------|--------|----------------------------|
| QR05025-C1C | 25° | - | Transparent Atomization |
| QR05040-C1C | 40° | - | Transparent Atomization |

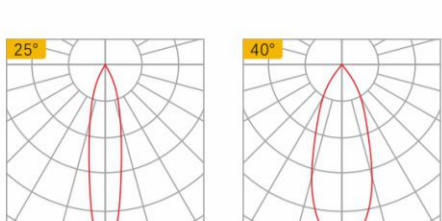

光源/SOURCE / LES 13-18mm

| | |
|----------|--|
| Citizen | CLU038 / CLU03J / CLU03Q |
| CREE | CMA1840 / CMB1840 / CMT1925 / CMT1940 CMU1516 / CMU1519 / CMU1526 |
| Lumens | 2032H2 |
| Lumileds | 1204 / 1205 / 1208 / L08F14 / L08x15 / L10x15 |
| Osram | S14 |

| | |
|----------|-----------------------------------|
| Nichia | NFCWJ108B / NFDWJ130B / NVEWJ048Z |
| Tridonic | SLE 15mm |
| Samsung | LC016D / LC019D / LC026D / LC033D |
| Seoul | SAWS1564A / SAWS1566A |

支架/HOLDERS

| Type | COB size(mm) | COB LES(mm) | Size(mm) | Material | Screw size |
|-------------|--------------|-------------|---------------|----------|------------|
| CRH1816-P | 17.85×17.85 | 10-15 | ø36.2×4.1 | PC | M2.5 |
| BCH1330-A | 19×19 | 10-17 | ø40×2.0 | PA9T | M3 |
| CHL030-A | 19×19 | 10-17 | ø36.2×2 | PA9T | M3 |
| CHL030-P | 19×19 | 10-17 | 29.4×29.4×3.2 | PC | M3 |
| H161919B-01 | 19×19 | 10-16 | ø35×3.5 | PC | M3 |
| BRHV1518-A | 21×21 | 14-19 | ø50×2.0 | PA9T | M3 |
| BRHV015-P | 21×21 | 14-17 | ø36.2×3.0 | PC | M2.5 |
| TRH0017-P | 21×21 | 14-17 | ø36×3.2 | PC | M2.5 |
| SAHC026-P | 21.5×21.5 | 14-18 | ø34×4.4 | PC | M2.5 |
| NIHN216-P | 24×19 | 14-18 | ø36.2×3.0 | PC | M2.5 |
| H182420A-01 | 24×20 | 14-18 | ø35×3.2 | PC | M2.5 |
| PIH1208-P | 24×20 | 14-17 | ø36.2×4.0 | PC | M2.5 |
| SHHMEGA-P | 24×20 | 12-17 | ø35×3.7 | PC | M3 |
| CRH2520-P | 24×24 | 14-18 | ø38×2.9 | PC | M2.5 |

P.27 | Reflector

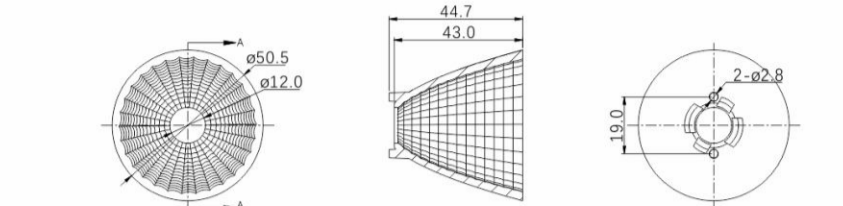

QR050-C1N

| Model型号 | FWHM Angle角度 | Lens透镜 | Cover灯盖 |
|-------------|--------------|--------|---------|
| QR05020-C1N | 20° | - | - |
| QR05038-C1N | 38° | - | - |

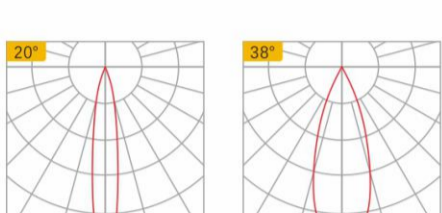

光源/SOURCE / LES 8-12mm

| | |
|-----------|--|
| Bridgelux | V10 / EB CA / E10 / V10 gen7-gen8-gen9 CLU028 / CLU02J / CLU02Q / CLU703 CLU702 / CLU701 |
| CREE | CHA0612 / CMA1516 / CMB1507 / CMB1510 CMB1516 / CMT1407 / CMT1412 / CMT1420 CMU1003 / CMU1006 / CMU1010 / CMU1013 CXB1507 / CXB1512 / CXB1520 |
| Lumens | ERC1507HO / ERC1512HO / L309H2 / L318H2 |
| Lumileds | 1202s / L02x09 / L04x09 / S04H9 / M02F09 M03F09 |

| | |
|----------|--|
| Luminus | CXM-6-AC30 gen3 / CXM-6 gen6 CHM-6-BH40 / CXM-6 LUX / CHM-9 gen3 CIM-9 gen4 / CLM-9-AC40 gen4 CXM-9-AC40 gen4 / CLM-9 gen6 CXM-9-TC60 gen6 |
| Osram | S9 |
| Nichia | NFCWS024B / NJCWS024Z / NFCWL036B NVEWL016Z |
| Tridonic | SLE 06mm / SLE 09mm |
| Samsung | LC003D / LC006D / LC009D / LC013D |
| Samsung | SAWS1063A |

支架/HOLDERS

| Type | COB size(mm) | COB LES(mm) | Size(mm) | Material | Screw size |
|-------------|--------------|-------------|-----------|----------|------------|
| BRHV068-F | 12.5×12.5 | 3-9 | ø28×2 | PA9T | M2.5 |
| BCH1020-A | 13.5×13.5 | 3-11.5 | ø28×2 | PA9T | M2.5 |
| CHL020-A | 13.5×13.5 | 3-11.5 | ø28×2 | PA9T | M2.5 |
| CHL020-P | 13.5×13.5 | 3-11.5 | ø25.3×2.0 | PC | M2.5 |
| H121313E-01 | 13.5×13.5 | 3-11 | ø35×4.3 | PC | M2.5 |
| H121414E-01 | 13.5×13.5 | 3-12 | ø27×4.0 | PC | M2.5 |
| H11512C-02 | 15×12 | 3-11 | ø28×2 | PA9T | M2.5 |
| H11512D-01 | 15×12 | 3-11 | ø25×3.2 | PC | M2.5 |
| SHHMINI-P | 15×12 | 3-10 | ø25.6×2.0 | PC | M2.5 |
| BRHV010-C | 15.8×15.8 | 3-12 | ø28×2 | PA9T | M2.5 |
| BRHV010-P | 15.8×15.8 | 3-12 | ø28×3.5 | PC | M2.5 |
| CRH1507-P | 15.85×15.85 | 3-11 | ø26.9×2.0 | PC | M2.5 |
| H111616A-01 | 15.85×15.85 | 3-11 | ø27.5×4.0 | PC | M2.5 |
| H111616B-01 | 15.85×15.85 | 3-11 | ø27.5×4.0 | PC | M2.5 |
| H111616C-01 | 15.85×15.85 | 3-11 | ø25×4.0 | PC | M2.5 |
| H121616B-01 | 15.85×15.85 | 3-12 | ø27×3.5 | PC | M2.5 |
| NIHN036-P | 19×16 | 3-11 | ø30.2×3.0 | PC | M2.5 |
| NIHN066-P | 19×16 | 3-11 | ø30.2×3.0 | PC | M2.5 |
| PIH1203-P | 19×16 | 3-11 | ø30.2×3.2 | PC | M2.5 |

P.28 | Reflector

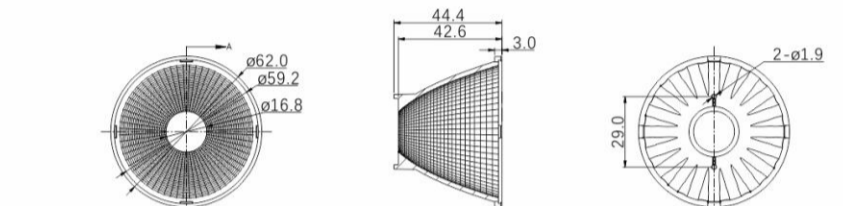

BR062-BV13

| Model型号 | FWHM Angle角度 | Lens透镜 | Cover灯盖 |
|-------------|--------------|--------|----------------------------|
| BR06215-C1C | 15° | - | Transparent Atomization |
| BR06230-C1C | 30° | - | Transparent Atomization |
| BR06260-C1C | 60° | - | Transparent Atomization |

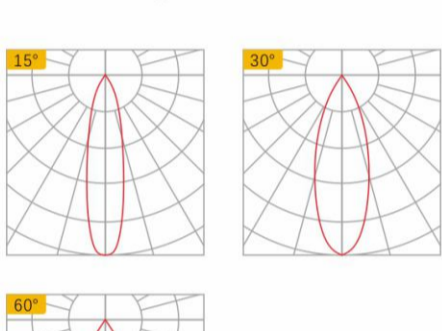

光源/SOURCE / LES 10-14mm

| | |
|-----------|---|
| Bridgelux | E8 CA / V13 gen7 / V9 HD gen7-gen8 V11 HD gen8 / Ver013 |
| Citizen | CLU723 / CLU721 |
| CREE | CXB1816 / CXB1820 / CHA0825 / CMA1516 CMA1825 / CMB1510 / CMB1516 / CMB1818 CMB1825 |
| Lumens | ERC1507HO / ERC1512HO / ERC1812HO ERC1820HO |

| | |
|----------|--|
| Lumileds | L202 / 1203 / S04H9 / M02F09 / M03F09 L04F12 / L05F12 |
| Luminus | CHM-9-BH40 / CXM-11 gen3 CXM-11 gen4 / CXM-11 LUX |
| Nichia | NFCWL036B / NVEWL016Z / NFCWL060B NVCWL024Z |
| Tridonic | SLE 13mm |
| Samsung | LC030C |

支架/HOLDERS

| Type | COB size(mm) | COB LES(mm) | Size(mm) | Material | Screw size |
|-------------|--------------|-------------|---------------|----------|------------|
| BRHV013-A | 15.8×15.8 | 10-14 | ø40×2 | PA9T | M3 |
| BRHV013-C | 15.85×15.85 | 10-15 | ø36.2×2.0 | PC | M3 |
| CRH1816-P | 17.85×17.85 | 10-15 | ø36.2×4.1 | PC | M2.5 |
| SAHL013-P | 17×17 | 10-13 | ø37.6×3.7 | PC | M3 |
| BCH1330-A | 19×19 | 10-17 | ø40×2 | PA9T | M3 |
| CHL030-A | 19×19 | 10-17 | ø36.2×2 | PA9T | M3 |
| CHL030-P | 19×19 | 10-17 | 29.4×29.4×3.2 | PC | M3 |
| H161919B-01 | 19×19 | 10-16 | ø35×3.5 | PC | M3 |
| NIHN121-P | 19×16 | 10-15 | ø37.6×3.7 | PC | M2.5 |
| PIH1204-P | 24×19 | 10-15 | ø37.6×4.1 | PC | M2.5 |

P.29 | Reflector

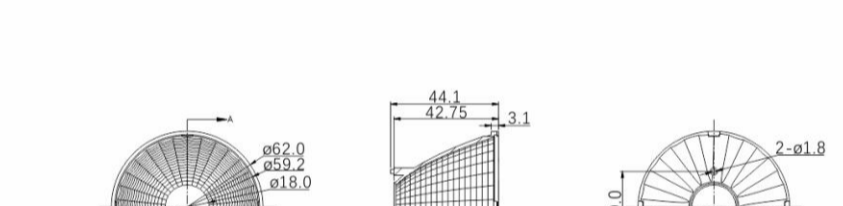

BR062-BV18

| Model型号 | FWHM Angle角度 | Lens透镜 | Cover灯盖 |
|-------------|--------------|--------|----------------------------|
| BR06215-C1C | 15° | - | Transparent Atomization |
| BR06230-C1C | 30° | - | Transparent Atomization |
| BR06260-C1C | 60° | - | Transparent Atomization |

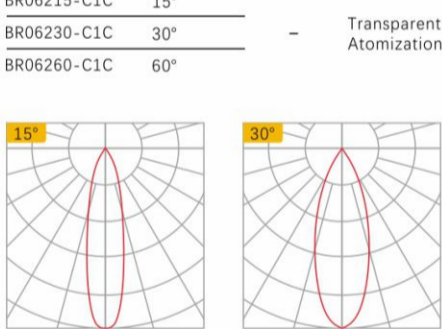

光源/SOURCE / LES 13-18mm

| | |
|-----------|--|
| Bridgelux | E10 / V15 gen7-gen8-gen9 / V9 HD gen7-gen8 V11 HD gen8 / Ver018 |
|-----------|--|

| | |
|----------|--|
| Lumileds | L202 / 1203 / S04H9 / M02F09 / M03F09 L04F12 / L05F12 |
| Luminus | CHM-9-BH40 / CXM-6 LUX CGM-14 gen3 / CXM-14 gen4 CGM-14 gen4 / CXM-14 gen4 / CGM-14 gen6 CLM-14 gen6 / CLM-14 gen6 / CXM-14 gen6 CLM-14-TC50 LUX |

支架/HOLDERS

| Type | COB size(mm) | COB LES(mm) | Size(mm) | Material | Screw size |
|-------------|--------------|-------------|---------------|----------|------------|
| CRH1816-P | 17.85×17.85 | 10-15 | ø36.2×4.1 | PC | M2.5 |
| BCH1330-A | 19×19 | 10-17 | ø40×2.0 | PA9T | M3 |
| CHL030-A | 19×19 | 10-17 | ø36.2×2 | PA9T | M3 |
| CHL030-P | 19×19 | 10-17 | 29.4×29.4×3.2 | PC | M3 |
| H161919B-01 | 19×19 | 10-16 | ø35×3.5 | PC | M3 |
| BRHV1518-A | 21×21 | 14-19 | ø50×2.0 | PA9T | M3 |
| BRHV015-P | 21×21 | 14-17 | ø36.2×3.0 | PC | M2.5 |
| TRH0017-P | 21×21 | 14-17 | ø36×3.2 | PC | M2.5 |
| SAHC026-P | 21.5×21.5 | 14-18 | ø34×4.4 | PC | M2.5 |
| NIHN216-P | 24×19 | 14-18 | ø36.2×3.0 | PC | M2.5 |
| H182420A-01 | 24×20 | 14-18 | ø35×3.2 | PC | M2.5 |
| PIH1208-P | 24×20 | 14-17 | ø36.2×4.0 | PC | M2.5 |
| SHHMEGA-P | 24×20 | 12-17 | ø35×3.7 | PC | M3 |

P.30 | Reflector

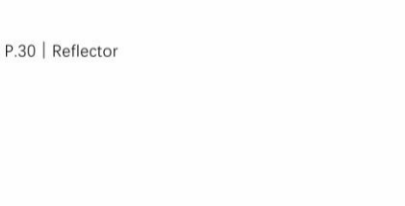

QR062-C1C

| Model型号 | FWHM Angle角度 | Lens透镜 | Cover灯盖 |
|-------------|--------------|--------|----------------------------|
| QR06215-C1C | 15° | - | Transparent Atomization |
| QR06230-C1C | 30° | - | Transparent Atomization |



光源/SOURCE / LES 13-18mm

| | |
|----------|--|
| Citizen | CLU038 / CLU03J / CLU03Q |
| CREE | CMA1840 / CMB1840 / CMT1925 / CMT1940 CMU1516 / CMU1519 / CMU1526 |
| Lumens | 2032H2 |
| Lumileds | 1204 / 1205 / 1208 / L08F14 / L08x15 / L10x15 |
| Osram | S14 |

| | |
|----------|-----------------------------------|
| Nichia | NFCWJ108B / NFDWJ130B / NVEWJ048Z |
| Tridonic | SLE 15mm |
| Samsung | LC016D / LC019D / LC026D / LC033D |
| Seoul | SAWS1564A / SAWS1566A |

支架/HOLDERS

| Type | COB size(mm) | COB LES(mm) | Size(mm) | Material | Screw size |
|-------------|--------------|-------------|---------------|----------|------------|
| CRH1816-P | 17.85×17.85 | 10-15 | ø36.2×4.1 | PC | M2.5 |
| BCH1330-A | 19×19 | 10-17 | ø40×2.0 | PA9T | M3 |
| CHL030-A | 19×19 | 10-17 | ø36.2×2 | PA9T | M3 |
| CHL030-P | 19×19 | 10-17 | 29.4×29.4×3.2 | PC | M3 |
| H161919B-01 | 19×19 | 10-16 | ø35×3.5 | PC | M3 |
| BRHV1518-A | 21×21 | 14-19 | ø50×2.0 | PA9T | M3 |
| BRHV015-P | 21×21 | 14-17 | ø36.2×3.0 | PC | M2.5 |
| TRH0017-P | 21×21 | 14-17 | ø36×3.2 | PC | M2.5 |
| SAHC026-P | 21.5×21.5 | 14-18 | ø34×4.4 | PC | M2.5 |
| NIHN216-P | 24×19 | 14-18 | ø36.2×3.0 | PC | M2.5 |
| H182420A-01 | 24×20 | 14-18 | ø35×3.2 | PC | M2.5 |
| PIH1208-P | 24×20 | 14-17 | ø36.2×4.0 | PC | M2.5 |
| SHHMEGA-P | 24×20 | 12-17 | ø35×3.7 | PC | M3 |
| CRH2520-P | 24×24 | 14-18 | ø38×2.9 | PC | M2.5 |

P.31 | Reflector

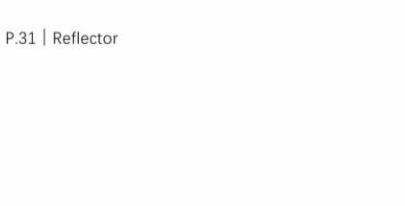

WE062-C1C

| Model型号 | FWHM Angle角度 | Lens透镜 | Cover灯盖 |
|-------------|--------------|--------|----------------------------|
| WE06210-C1C | 10° | - | Transparent Atomization |
| WE06218-C1C | 18° | - | Transparent Atomization |
| WE06230-C1C | 30° | - | Transparent Atomization |
| WE06238-C1C | 38° | - | Transparent Atomization |



光源/SOURCE / LES 8-12mm

| | |
|-----------|--|
| Bridgelux | V10 gen7 / EB CA / E10 / V10 gen7-gen8-gen9 CLU028 / CLU02J / CLU02Q / CLU703 CLU702 / CLU701 |
| Citizen | CLU028 / CLU02J / CLU02Q / CLU703 CLU702 / CLU701 |
| CREE | CHA0612 / CMA1516 / CMB1507 / CMB1510 CMB1516 / CMT1407 / CMT1412 / CMT1420 CMU1003 / CMU1006 / CMU1010 / CMU1013 CXB1507 / CXB1512 / CXB1520 |
| Lumens | ERC1507HO / ERC1512HO / L309H2 / L318H2 |
| Lumileds | 1202s / L02x09 / L04x09 / S04H9 / M02F09 M03F09 |

| | |
|----------|---|
| Luminus | CXM-6-AC30 gen3 / CXM-6 gen6 CHM-6-BH40 / CXM-6 LUX CHM-9 gen3 / CIM-9 gen4 CLM-9 gen6 / CXM-9-TC60 gen4 |
| Osram | S9 |
| Nichia | NFCWS024B / NJCWS024Z / NFCWL036B NVEWL016Z |
| Tridonic | SLE 06mm / SLE 09mm |
| Samsung | LC003D / LC006D / LC009D / LC013D |
| Samsung | SAWS1063A |

支架/HOLDERS

| Type | COB size(mm) | COB LES(mm) | Size(mm) | Material | Screw size |
|-----------|--------------|-------------|----------|----------|------------|
| BRHV068-F | 12.5×12.5 | 3-9 | ø28×2 | PA9T | M2.5 |
| BCH1020-A | 13.5×13.5 | 3-11.5 | ø28×2 | PA9T | M2.5 |
| CHL020-A | 13.5×13.5 | 3-11.5 | ø28×2 | PA9T | M2.5 |
| CHL020-P | 13.5×13.5 | | | | |



CR065-C1C

| Model型号 | FWHM Angle角度 | Lens透镜 | Cover灯盖 |
|--------------|--------------|--------|-------------|
| CR06516N-C1C | 16° | Yes | Transparent |
| CR06524-C1C | 24° | | |
| CR06534-C1C | 34° | | |

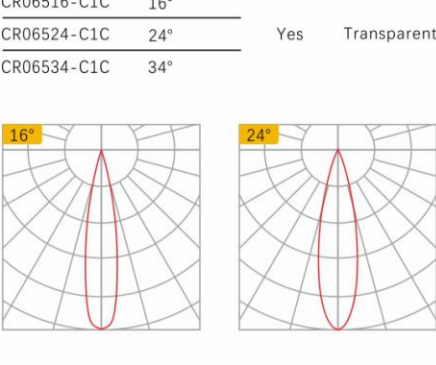

| Type | COB size(mm) | COB LES(mm) | Size(mm) | Material | Screw size |
|------------|----------------------|-------------|-----------|----------|------------|
| BRHV013-A | 15.8×15.8 | 10-14 | ø40×2 | PA9T | M3 |
| BRHV013-C | 15.85×15.85 | 10-15 | ø36.2×2.0 | PC | M3 |
| BCH1330-A | 19×19 | 10-17 | ø40×2 | PA9T | M3 |
| CIHL030-A | 19×19 | 10-17 | ø36.2×2 | PA9T | M3 |
| LSHM9MI-A | 15×15 15×12 | 8-11 | 50×44×2.2 | PC | M3 |
| CRH1830-A | 15.85×15.85 18×18 | 10-16 | 50×44×2.2 | PC | M3 |
| LUH1114-A | 18.5×18.5 18.5×15 | 10-16 | 50×44×2.2 | PC | M3 |
| CIHL030-B | 19×19 21×21 | 10-17 | 50×44×2.2 | PC | M3 |
| SHHMEGA-PC | 24×24 24×20 | 12-22 | 50×44×2.2 | PC | M3 |

P.33 | Reflector

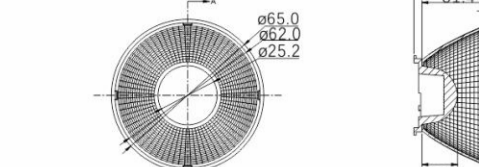

光源/SOURCE / LES 10-15mm

| | |
|-----------|--|
| Bridgelux | E8 CA / V13 gen7-gen8-gen9 V9 HD gen7-gen8 / V11 HD gen8 |
| Citizen | CLU723 / CLU721 |
| CREE | CXB1507 / CXB1512 / CXB1520 / CXB1816 CXB1820 / CXB1830 / CHA0825 / CMA1516 CMA1825 / CMB1507 / CMB1510 / CMB1516 CMB1818 / CMB1825 / CMB1840 |
| Lumens | ERC1507HO / ERC1512HO / ERC1812HO ERC1820HO |
| Lumileds | 1202S / 1204 / 1205 / S04H9 / M02F09 M03F09 / L06x13 |

| | |
|----------|--|
| Luminus | CHM-9-BH40 / CXM-11 gen3 CXM-11 gen4 / CXM-11 LUX |
| Osram | S9 |
| Nichia | NFCWL036B / NVEWL016Z / NFCWL060B NVVWL024Z |
| Tridonic | SLE 13mm |
| Samsung | LC020C / LC030C |

支架/HOLDERS

| Type | COB size(mm) | COB LES(mm) | Size(mm) | Material | Screw size |
|------------|----------------------|-------------|-----------|----------|------------|
| BRHV013-A | 15.8×15.8 | 10-14 | ø40×2 | PA9T | M3 |
| BRHV013-C | 15.85×15.85 | 10-15 | ø36.2×2.0 | PC | M3 |
| BCH1330-A | 19×19 | 10-17 | ø40×2 | PA9T | M3 |
| CIHL030-A | 19×19 | 10-17 | ø36.2×2 | PA9T | M3 |
| LSHM9MI-A | 15×15 15×12 | 8-11 | 50×44×2.2 | PC | M3 |
| CRH1830-A | 15.85×15.85 18×18 | 10-16 | 50×44×2.2 | PC | M3 |
| LUH1114-A | 18.5×18.5 18.5×15 | 10-16 | 50×44×2.2 | PC | M3 |
| CIHL030-B | 19×19 21×21 | 10-17 | 50×44×2.2 | PC | M3 |
| SHHMEGA-PC | 24×24 24×20 | 12-22 | 50×44×2.2 | PC | M3 |



R065BN-10

| Model型号 | FWHM Angle角度 | Lens透镜 | Cover灯盖 |
|-------------|--------------|--------|---------|
| R06516BN-10 | 16° | Yes | - |
| R06524BN-10 | 24° | | |
| R06536BN-10 | 36° | | |

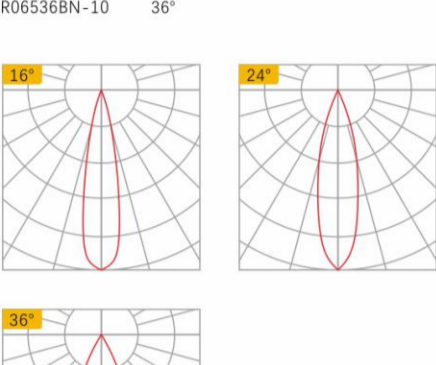

P.34 | Reflector

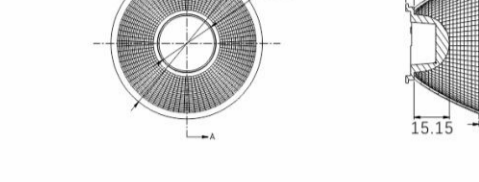

光源/SOURCE / LES 10-15mm

| | |
|-----------|--|
| Bridgelux | E8 CA / V13 gen7-gen8-gen9 V9 HD gen7-gen8 / V11 HD gen8 |
| Citizen | CLU723 / CLU721 |
| CREE | CXB1507 / CXB1512 / CXB1520 / CXB1816 CXB1820 / CXB1830 / CHA0825 / CMA1516 CMA1825 / CMB1507 / CMB1510 / CMB1516 CMB1818 / CMB1825 / CMB1840 |
| Lumens | ERC1507HO / ERC1512HO / ERC1812HO ERC1820HO |
| Lumileds | 1202S / 1204 / 1205 / S04H9 / M02F09 M03F09 / L06x13 |

| | |
|----------|--|
| Luminus | CHM-9-BH40 / CXM-11 gen3 CXM-11 gen4 / CXM-11 LUX |
| Osram | S9 |
| Nichia | NFCWL036B / NVEWL016Z / NFCWL060B NVVWL024Z |
| Tridonic | SLE 13mm |
| Samsung | LC020C / LC030C |

支架/HOLDERS

| Type | COB size(mm) | COB LES(mm) | Size(mm) | Material | Screw size |
|------------|----------------------|-------------|-----------|----------|------------|
| BRHV013-A | 15.8×15.8 | 10-14 | ø40×2 | PA9T | M3 |
| BRHV013-C | 15.85×15.85 | 10-15 | ø36.2×2.0 | PC | M3 |
| BCH1330-A | 19×19 | 10-17 | ø40×2 | PA9T | M3 |
| CIHL030-A | 19×19 | 10-17 | ø36.2×2 | PA9T | M3 |
| LSHM9MI-A | 15×15 15×12 | 8-11 | 50×44×2.2 | PC | M3 |
| CRH1830-A | 15.85×15.85 18×18 | 10-16 | 50×44×2.2 | PC | M3 |
| LUH1114-A | 18.5×18.5 18.5×15 | 10-16 | 50×44×2.2 | PC | M3 |
| CIHL030-B | 19×19 21×21 | 10-17 | 50×44×2.2 | PC | M3 |
| SHHMEGA-PC | 24×24 24×20 | 12-22 | 50×44×2.2 | PC | M3 |



BR075-BV13

| Model型号 | FWHM Angle角度 | Lens透镜 | Cover灯盖 |
|-------------|--------------|--------|----------------------------|
| BR07515-C1C | 15° | - | Transparent Atomization |
| BR07530-C1C | 30° | | |
| BR07540-C1C | 40° | | |

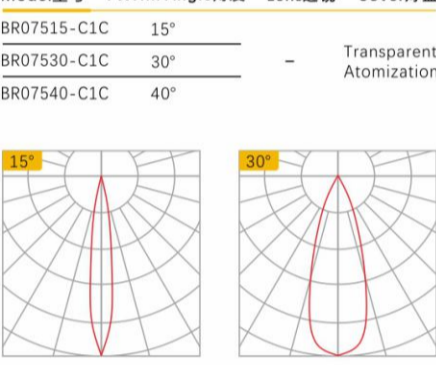

P.35 | Reflector

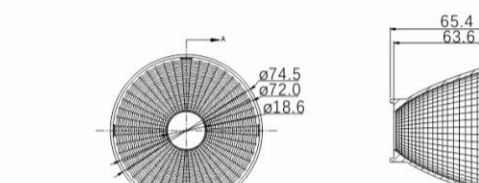

光源/SOURCE / LES 10-15mm

| | |
|-----------|---|
| Bridgelux | E8 CA / V13 gen7 / V9 HD gen7-gen8 V11 HD gen8 / Vero13 |
| Citizen | CLU723 / CLU721 |
| CREE | CXB1816 / CXB1820 / CHA0825 / CMA1516 CMA1825 / CMB1510 / CMB1516 / CMB1818 CMB1825 |
| Lumens | ERC1507HO / ERC1512HO / ERC1812HO ERC1820HO |

| | |
|----------|--|
| Lumileds | 1202 / 1203 / S04H9 / M02F09 / M03F09 L04F12 / L05F12 |
| Luminus | CHM-9-BH40 / CXM-11 gen3 CXM-11 gen4 / CXM-11 LUX |
| Nichia | NFCWL036B / NVEWL016Z / NFCWL060B NVVWL024Z |
| Tridonic | SLE 13mm |
| Samsung | LC030C |

支架/HOLDERS

| Type | COB size(mm) | COB LES(mm) | Size(mm) | Material | Screw size |
|-------------|--------------|-------------|---------------|----------|------------|
| BRHV013-A | 15.8×15.8 | 10-14 | ø40×2 | PA9T | M3 |
| BRHV013-C | 15.85×15.85 | 10-15 | ø36.2×2.0 | PC | M3 |
| BRH1816-P | 17.85×17.85 | 10-15 | ø36.2×4.1 | PC | M2.5 |
| SAHL013-P | 17×17 | 10-13 | ø37.6×3.7 | PC | M3 |
| BCH1330-A | 19×19 | 10-17 | ø40×2 | PA9T | M3 |
| CIHL030-A | 19×19 | 10-17 | ø36.2×2 | PA9T | M3 |
| CIHL030-B | 19×19 | 10-17 | 29.4×29.4×3.2 | PC | M3 |
| H161919B-01 | 19×19 | 10-16 | ø35×3.5 | PC | M3 |
| NH121-P | 19×16 | 10-15 | ø37.6×3.7 | PC | M2.5 |
| PIH1204-P | 24×19 | 10-15 | ø37.6×4.1 | PC | M2.5 |



BR075-BV18

| Model型号 | FWHM Angle角度 | Lens透镜 | Cover灯盖 |
|-------------|--------------|--------|----------------------------|
| BR07515-C1C | 15° | - | Transparent Atomization |
| BR07530-C1C | 30° | | |
| BR07538-C1C | 40° | | |

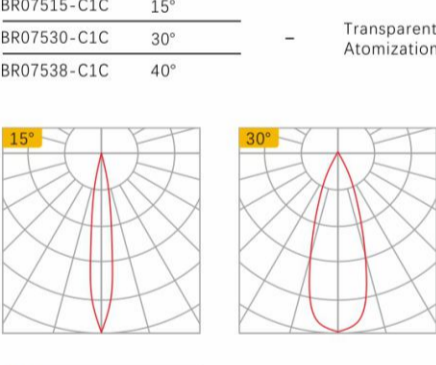

P.36 | Reflector

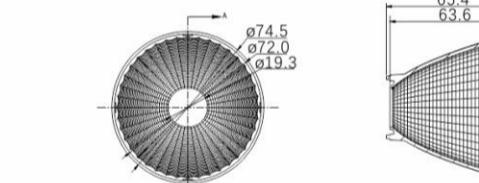

光源/SOURCE / LES 13-18mm

| | |
|-----------|--|
| Bridgelux | E10 / V15 gen7-gen8-gen9 / V9 HD gen7-gen8 V11 HD gen8 / Vero18 |
|-----------|--|

| | |
|---------|--|
| Luminus | CIM-14-AC30 gen3 / CLM-14-AC30 gen3 CIM-14-AC30 gen3 / CIM-14 gen4 CGM-14 gen4 / CXM-14 gen4 / CGM-14 gen6 CLM-14 gen6 / CXM-14 gen6 / CXM-14 gen6 CLM-14-TC50 LUX |
|---------|--|

支架/HOLDERS

| Type | COB size(mm) | COB LES(mm) | Size(mm) | Material | Screw size |
|-------------|--------------|-------------|---------------|----------|------------|
| CRH1816-P | 17.85×17.85 | 10-15 | ø36.2×4.1 | PC | M2.5 |
| BRHV013-A | 15.8×15.8 | 10-14 | ø40×2 | PA9T | M3 |
| BRHV013-C | 15.85×15.85 | 10-15 | ø36.2×2.0 | PC | M3 |
| CIHL030-A | 19×19 | 10-17 | ø36.2×2 | PA9T | M3 |
| CIHL030-P | 19×19 | 10-17 | 29.4×29.4×3.2 | PC | M3 |
| H161919B-01 | 19×19 | 10-16 | ø35×3.5 | PC | M3 |
| BRHV1518-A | 21×21 | 14-19 | ø50×2.0 | PA9T | M3 |
| BRHV015-P | 21×21 | 14-17 | ø36.2×3.0 | PC | M2.5 |
| TRH0017-P | 21×21 | 14-17 | ø36×3.2 | PC | M2.5 |
| SAHC026-P | 21.5×21.5 | 14-18 | ø34×4.4 | PC | M2.5 |
| NH1216-P | 24×19 | 14-18 | ø36.2×3.0 | PC | M2.5 |
| H182420A-01 | 24×20 | 14-18 | ø35×3.2 | PC | M2.5 |
| PHI1208-P | 24×20 | 14-17 | ø36.2×4.0 | PC | M2.5 |
| SHHMEGA-P | 24×20 | 12-17 | ø35×3.7 | PC | M3 |



OP075-C1C

| Model型号 | FWHM Angle角度 | Lens透镜 | Cover灯盖 |
|-------------|--------------|--------|----------------------------|
| OP07520-C1C | 20° | Yes | Transparent Atomization |
| OP07530-C1C | 30° | | |
| OP07540-C1C | 40° | | |
| OP07560-C1C | 60° | | |

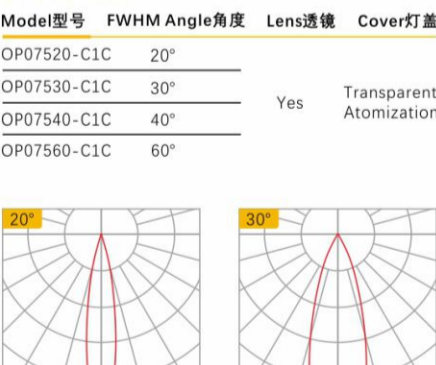

P.37 | Reflector

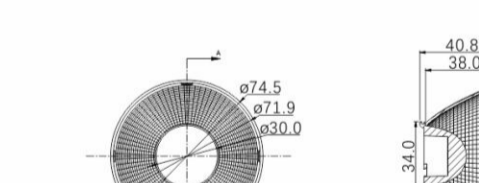

光源/SOURCE / LES 10-18mm

| | |
|-----------|--|
| Bridgelux | E8 CA / E15 / V13 gen7-gen8-gen9 V15 gen7-gen8-gen9 / V9 HD gen7-gen8 V11 HD gen8 |
| Citizen | CLU723 / CLU721 / CLU038 / CLU037 CLU03Q |
| CREE | CXB1507 / CXB1520 / CXB1816 / CXB1830 CHA0825 / CMA1516 / CMA1825 / CMB1507 CMB1516 / CMB1818 / CMB1825 / CMT1922 CMT1930 / CMU1519 / CMU1526 |
| Lumens | ERC1507HO / ERC1512HO / ERC1812HO ERC1820HO / 2025H2 / 2032H2 |
| Lumileds | 1202S / 1204 / 1205 / 1208 / S04H9 / M02F09 M03F09 / L06x13 / L08x15 / L10x15 |

| | |
|----------|---|
| Luminus | CHM-9-BH40 / CXM-11 gen4 / CXM-11 LUX CIM-14-AC30 gen3 / CIM-14-AC30 gen3 CXM-14 gen4 / CXM-14 gen6 / CIM-14 gen6 CLM-14 gen6 / CXM-14 gen6 / CXM-14 gen6 CLM-14-TC50 LUX |
| Osram | S9 / S14 / S19 |
| Nichia | NFCWL036B / NVEWL016Z / NFCWL060B NVVWL024Z |
| Samsung | SLE 13mm / SLE 15mm |
| Tridonic | LC020C / LC030C / LC016D / LC019D LC026D / LC033D |
| Seoul | SAWS1564A / SAWS1566A |

支架/HOLDERS

| Type | COB size(mm) | COB LES(mm) | Size(mm) | Material | Screw size |
|-------------|----------------------|-------------|---------------|----------|------------|
| BRHV013-A | 15.8×15.8 | 10-14 | ø40×2 | PA9T | M3 |
| BRHV013-C | 15.85×15.85 | 10-15 | ø36.2×2.0 | PC | M3 |
| BCH1330-A | 19×19 | 10-17 | ø40×2 | PA9T | M3 |
| CIHL030-A | 19×19 | 10-17 | ø36.2×2 | PA9T | M3 |
| CIHL030-P | 19×19 | 10-17 | 29.4×29.4×3.2 | PC | M3 |
| H161919B-01 | 19×19 | 10-16 | ø35×3.5 | PC | M3 |
| BRHV1518-A | 21×21 | 14-19 | ø50×2.0 | PA9T | M3 |
| BCHV1825-A | 24×24 | 16-21 | ø50×2.0 | PA9T | M3 |
| LSHM9MI-A | 15×15 15×12 | 8-11 | 50×44×2.2 | PC | M3 |
| CRH1830-A | 15.85×15.85 18×18 | 10-16 | 50×44×2.2 | PC | M3 |
| LUH1114-A | 18.5×18.5 18.5×15 | 10-16 | 50×44×2.2 | PC | M3 |
| CIHL030-B | 19×19 21×21 | 10-17 | 50×44×2.2 | PC | M3 |
| SHHMEGA-PC | 24×24 24×20 | 12-22 | 50×44×2.2 | PC | M3 |



QR075-C1C

| Model型号 | FWHM Angle角度 | Lens透镜 | Cover灯盖 |
|-------------|--------------|--------|----------------------------|
| QR07515-C1C | 15° | - | Transparent Atomization |
| QR07530-C1C | 30° | | |
| QR07532-C1C | 32° | | |
| QR07538-C1C | 38° | | |

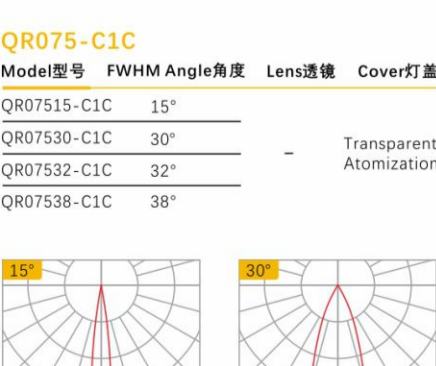

P.38 | Reflector

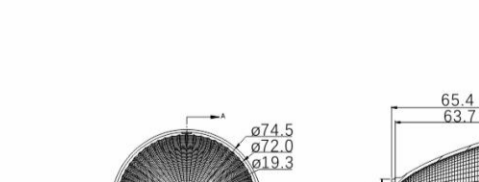

光源/SOURCE / LES 13-18mm

| | |
|----------|--|
| Citizen | CLU038 / CLU031 / CLU03Q |
| CREE | CMA1840 / CMB1840 / CMT1925 / CMT1940 CMU1516 / CMU1519 / CMU1526 |
| Lumens | 2023H2 |
| Lumileds | 1204 / 1205 / 1208 / L08F14 / L08x15 / L10x15 |
| Osram | S14 |

| | |
|----------|-----------------------------------|
| Nichia | NFCWJ108B / NFDWJ130B / NVEWJ048Z |
| Tridonic | SLE 15mm |
| Samsung | LC016D / LC019D / LC026D / LC033D |
| Seoul | SAWS1564A / SAWS1566A |

支架/HOLDERS

| Type | COB size(mm) | COB LES(mm) | Size(mm) | Material | Screw size |
|-----------|--------------|-------------|----------|----------|------------|
| CRH1816-P | 17. | | | | |



R075DC-10

| Model型号 | FWHM Angle角度 | Lens透镜 | Cover灯盖 |
|-------------|--------------|--------|-------------------------|
| R07515DC-10 | 15° | - | Transparent Atomization |
| R07524DC-10 | 24° | | |
| R07538DC-10 | 38° | | |

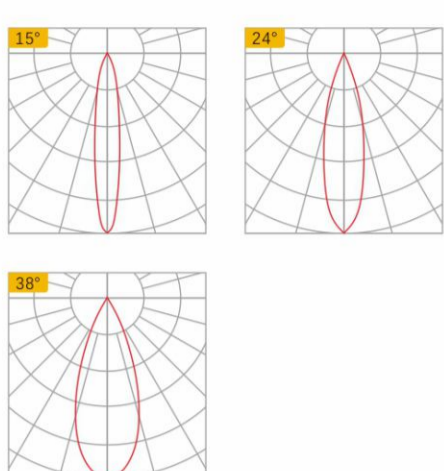

P.41 | Reflector

光源/SOURCE / LES 10~18mm

| | |
|------------------|--|
| Bridgelux | E8 CA / E15 / V13 gen7·gen8·gen9 V15 gen7·gen8·gen9 / V9 HD gen7·gen8 V11 HD gen8 |
| Citizen | CLU723 / CLU721 / CLU038 / CLU03J CLU03Q |
| CREE | CXB1507 / CXB1520 / CXB1816 / CXB1830 CHA0825 / CMA1516 / CMA1825 / CMB1507 CMB1516 / CMB1818 / CMB1825 / CMT1922 CMT1930 / CMU1519 / CMU1526 |
| Lumens | ERC1507HO / ERC1512HO / ERC1812HO ERC1820HO / 2025H2 / 2032H2 |
| Lumileds | 1202S / 1204 / 1205 / 1208 / S04H9 / M02F09 M03F09 / L06x13 / L08x15 / L10x15 |

| | |
|-----------------|---|
| Luminus | CHM-9-BH40 / CXM-11 gen4 / CXM-11 LUX CIM-14-AC30 gen3 / CXM-14-AC30 gen3 CXM-14 gen4 / CGM-14 gen6 / CIM-14 gen6 CLM-14 gen6 / CXM-14 gen6 CLM-14-TC50 LUX |
| Osram | S9 / S14 / S19 |
| Nichia | NFCWL036B / NVEWL016Z / NFCWL060B NVICWL024Z |
| Tridonic | SLE 13mm / SLE 15mm |
| Samsung | LC020C / LC030C / LC016D / LC019D LC026D / LC033D |
| Seoul | SAWS1564A / SAWS1566A |

支架/HOLDERS

| Type | COB size(mm) | COB LES(mm) | Size(mm) | Material | Screw size |
|------------|----------------------|-------------|-----------|----------|------------|
| BRHV013-A | 15.8×15.8 | 10-14 | ø40×2 | PA9T | M3 |
| BRHV013-C | 15.85×15.85 | 10-15 | ø36.2×2.0 | PC | M3 |
| BCH1330-A | 19×19 | 10-17 | ø40×2 | PA9T | M3 |
| CIHL030-A | 19×19 | 10-17 | ø36.2×2 | PA9T | M3 |
| BRHV1518-A | 21×21 | 14-19 | ø50×2.0 | PA9T | M3 |
| BCHV1825-A | 24×24 | 16-21 | ø50×2.0 | PA9T | M3 |
| LSHM9MI-A | 15×15 15×12 | 8-11 | 50×44×2.2 | PC | M3 |
| CRH1830-A | 15.85×15.85 18×18 | 10-16 | 50×44×2.2 | PC | M3 |
| LUH1114-A | 18.5×18.5 18.5×15 | 10-16 | 50×44×2.2 | PC | M3 |
| CIHL030-B | 19×19 21×21 | 10-17 | 50×44×2.2 | PC | M3 |
| SHHMEGA-PC | 24×24 24×20 | 12-22 | 50×44×2.2 | PC | M3 |

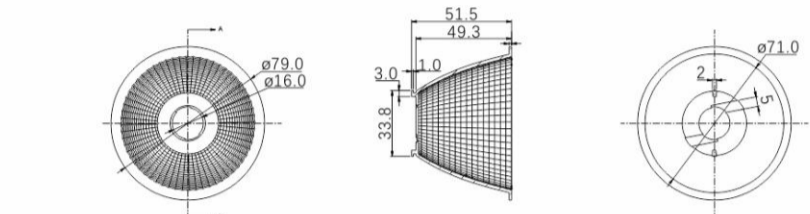

CR080-C1N

| Model型号 | FWHM Angle角度 | Lens透镜 | Cover灯盖 |
|-------------|--------------|--------|---------|
| CR08010-C1N | 10° | - | - |
| CR08024-C1N | 24° | | |
| CR08036-C1N | 36° | | |

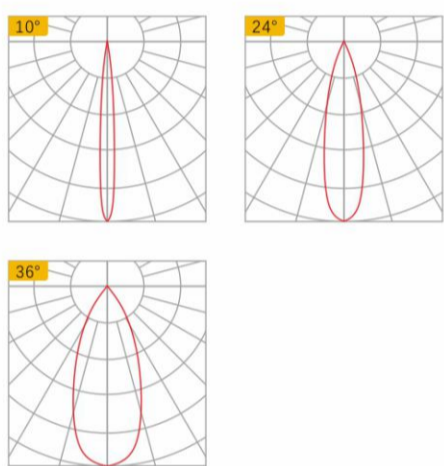

P.42 | Reflector

光源/SOURCE / LES 10~16mm

| | |
|------------------|--|
| Bridgelux | E8 CA / E15 / V13 gen7·gen8·gen9 V15 gen7·gen8·gen9 / V9 HD gen7·gen8 V11 HD gen8 |
| Citizen | CLU723 / CLU721 / CLU733 / CLU731 |
| CREE | CXB1507 / CXB1520 / CXB1816 / CXB1830 CHA0825 / CMA1516 / CMA1825 / CMB1507 CMB1516 / CMB1818 / CMB1825 / CMT1922 CMT1930 |
| Lumens | ERC1507HO / ERC1512HO / ERC1812HO ERC1820HO / 2025H2 / 2032H2 |
| Lumileds | 1202 / 1204 / 1205 / S04H9 / M02F09 M03F09 / L06x13 / L04F12 / L08F14 |

| | |
|-----------------|---|
| Luminus | CHM-9-BH40 / CXM-11 gen4 / CXM-11 LUX CIM-14-AC30 gen3 / CXM-14-AC30 gen3 CXM-14 gen4 / CGM-14 gen6 / CIM-14 gen6 CLM-14 gen6 / CXM-14 gen6 CLM-14-TC50 LUX |
| Osram | S14 |
| Nichia | NFCWL036B / NVEWL016Z / NFCWL060B NVICWL024Z |
| Tridonic | SLE 13mm |
| Samsung | LC020C / LC030C / LC040C |

支架/HOLDERS

| Type | COB size(mm) | COB LES(mm) | Size(mm) | Material | Screw size |
|------------|----------------------|-------------|-----------|----------|------------|
| BRHV013-A | 15.8×15.8 | 10-14 | ø40×2 | PA9T | M3 |
| BRHV013-C | 15.85×15.85 | 10-15 | ø36.2×2.0 | PC | M3 |
| BCH1330-A | 19×19 | 10-17 | ø40×2 | PA9T | M3 |
| CIHL030-A | 19×19 | 10-17 | ø36.2×2 | PA9T | M3 |
| BRHV1518-A | 21×21 | 14-19 | ø50×2.0 | PA9T | M3 |
| BCHV1825-A | 24×24 | 16-21 | ø50×2.0 | PA9T | M3 |
| LSHM9MI-A | 15×15 15×12 | 8-11 | 50×44×2.2 | PC | M3 |
| CRH1830-A | 15.85×15.85 18×18 | 10-16 | 50×44×2.2 | PC | M3 |
| LUH1114-A | 18.5×18.5 18.5×15 | 10-16 | 50×44×2.2 | PC | M3 |
| CIHL030-B | 19×19 21×21 | 10-17 | 50×44×2.2 | PC | M3 |
| SHHMEGA-PC | 24×24 24×20 | 12-22 | 50×44×2.2 | PC | M3 |



GQ085-C1C

| Model型号 | FWHM Angle角度 | Lens透镜 | Cover灯盖 |
|-------------|--------------|--------|-------------|
| GQ08515-C1C | 15° | Yes | Transparent |
| GQ08525-C1C | 25° | | |
| GQ08538-C1C | 38° | | |

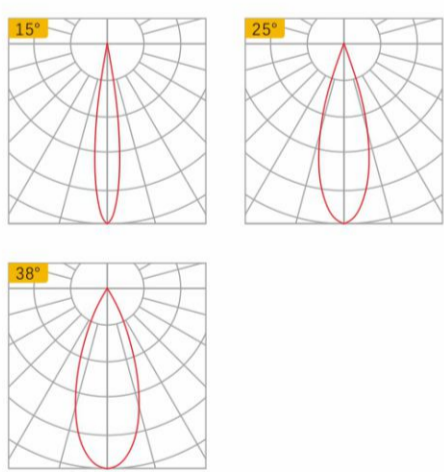

P.43 | Reflector

光源/SOURCE / LES 10~18mm

| | |
|------------------|--|
| Bridgelux | E8 CA / E15 / V13 gen7·gen8·gen9 V15 gen7·gen8·gen9 / V9 HD gen7·gen8 V11 HD gen8 |
| Citizen | CLU723 / CLU721 / CLU038 / CLU03J CLU03Q |
| CREE | CXB1507 / CXB1520 / CXB1816 / CXB1830 CHA0825 / CMA1516 / CMA1825 / CMB1507 CMB1516 / CMB1818 / CMB1825 / CMT1922 CMT1930 / CMU1519 / CMU1526 |
| Lumens | ERC1507HO / ERC1512HO / ERC1812HO ERC1820HO / 2025H2 / 2032H2 |
| Lumileds | 1202S / 1204 / 1205 / 1208 / S04H9 / M02F09 M03F09 / L06x13 / L08x15 / L10x15 |

| | |
|-----------------|---|
| Luminus | CHM-9-BH40 / CXM-11 gen4 / CXM-11 LUX CIM-14-AC30 gen3 / CXM-14-AC30 gen3 CXM-14 gen4 / CGM-14 gen6 / CIM-14 gen6 CLM-14 gen6 / CXM-14 gen6 CLM-14-TC50 LUX |
| Osram | S9 / S14 / S19 |
| Nichia | NFCWL036B / NVEWL016Z / NFCWL060B NVICWL024Z |
| Tridonic | SLE 13mm / SLE 15mm |
| Samsung | LC020C / LC030C / LC016D / LC019D LC026D / LC033D |
| Seoul | SAWS1564A / SAWS1566A |

支架/HOLDERS

| Type | COB size(mm) | COB LES(mm) | Size(mm) | Material | Screw size |
|------------|----------------------|-------------|-----------|----------|------------|
| BRHV013-A | 15.8×15.8 | 10-14 | ø40×2 | PA9T | M3 |
| BRHV013-C | 15.85×15.85 | 10-15 | ø36.2×2.0 | PC | M3 |
| BCH1330-A | 19×19 | 10-17 | ø40×2 | PA9T | M3 |
| CIHL030-A | 19×19 | 10-17 | ø36.2×2 | PA9T | M3 |
| BRHV1518-A | 21×21 | 14-19 | ø50×2.0 | PA9T | M3 |
| BCHV1825-A | 24×24 | 16-21 | ø50×2.0 | PA9T | M3 |
| LSHM9MI-A | 15×15 15×12 | 8-11 | 50×44×2.2 | PC | M3 |
| CRH1830-A | 15.85×15.85 18×18 | 10-16 | 50×44×2.2 | PC | M3 |
| LUH1114-A | 18.5×18.5 18.5×15 | 10-16 | 50×44×2.2 | PC | M3 |
| CIHL030-B | 19×19 21×21 | 10-17 | 50×44×2.2 | PC | M3 |
| SHHMEGA-PC | 24×24 24×20 | 12-22 | 50×44×2.2 | PC | M3 |



R085BN-10

| Model型号 | FWHM Angle角度 | Lens透镜 | Cover灯盖 |
|-------------|--------------|--------|---------|
| R08515BN-10 | 15° | Yes | - |
| R08525BN-10 | 25° | | |
| R08536BN-10 | 36° | | |

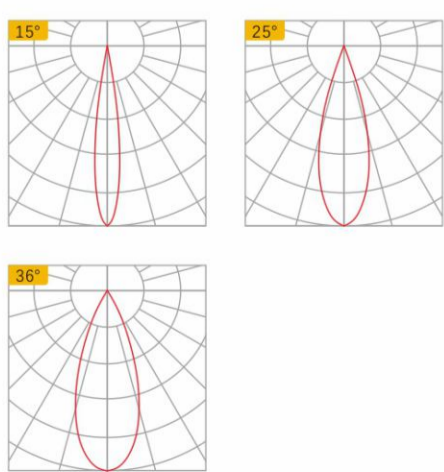

P.44 | Reflector

光源/SOURCE / LES 10~18mm

| | |
|------------------|--|
| Bridgelux | E8 CA / E15 / V13 gen7·gen8·gen9 V15 gen7·gen8·gen9 / V9 HD gen7·gen8 V11 HD gen8 |
| Citizen | CLU723 / CLU721 / CLU038 / CLU03J CLU03Q |
| CREE | CXB1507 / CXB1520 / CXB1816 / CXB1830 CHA0825 / CMA1516 / CMA1825 / CMB1507 CMB1516 / CMB1818 / CMB1825 / CMT1922 CMT1930 / CMU1519 / CMU1526 |
| Lumens | ERC1507HO / ERC1512HO / ERC1812HO ERC1820HO / 2025H2 / 2032H2 |
| Lumileds | 1202S / 1204 / 1205 / 1208 / S04H9 / M02F09 M03F09 / L06x13 / L08x15 / L10x15 |

| | |
|-----------------|---|
| Luminus | CHM-9-BH40 / CXM-11 gen4 / CXM-11 LUX CIM-14-AC30 gen3 / CXM-14-AC30 gen3 CXM-14 gen4 / CGM-14 gen6 / CIM-14 gen6 CLM-14 gen6 / CXM-14 gen6 CLM-14-TC50 LUX |
| Osram | S9 / S14 / S19 |
| Nichia | NFCWL036B / NVEWL016Z / NFCWL060B NVICWL024Z |
| Tridonic | SLE 13mm / SLE 15mm |
| Samsung | LC020C / LC030C / LC016D / LC019D LC026D / LC033D |
| Seoul | SAWS1564A / SAWS1566A |

支架/HOLDERS

| Type | COB size(mm) | COB LES(mm) | Size(mm) | Material | Screw size |
|------------|----------------------|-------------|-----------|----------|------------|
| BRHV013-A | 15.8×15.8 | 10-14 | ø40×2 | PA9T | M3 |
| BRHV013-C | 15.85×15.85 | 10-15 | ø36.2×2.0 | PC | M3 |
| BCH1330-A | 19×19 | 10-17 | ø40×2 | PA9T | M3 |
| CIHL030-A | 19×19 | 10-17 | ø36.2×2 | PA9T | M3 |
| BRHV1518-A | 21×21 | 14-19 | ø50×2.0 | PA9T | M3 |
| BCHV1825-A | 24×24 | 16-21 | ø50×2.0 | PA9T | M3 |
| LSHM9MI-A | 15×15 15×12 | 8-11 | 50×44×2.2 | PC | M3 |
| CRH1830-A | 15.85×15.85 18×18 | 10-16 | 50×44×2.2 | PC | M3 |
| LUH1114-A | 18.5×18.5 18.5×15 | 10-16 | 50×44×2.2 | PC | M3 |
| CIHL030-B | 19×19 21×21 | 10-17 | 50×44×2.2 | PC | M3 |
| SHHMEGA-PC | 24×24 24×20 | 12-22 | 50×44×2.2 | PC | M3 |



GQ093-C1C

| Model型号 | FWHM Angle角度 | Lens透镜 | Cover灯盖 |
|-------------|--------------|--------|-------------|
| GQ09315-C1C | 15° | | |
| GQ09324-C1C | 24° | | |
| GQ09330-C1C | 30° | Yes | Transparent |
| GQ09338-C1C | 38° | | |

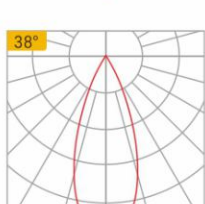
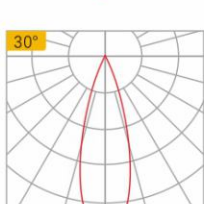
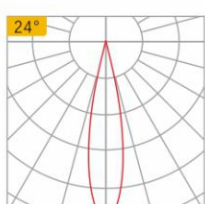
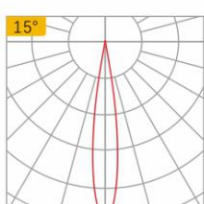

P.45 | Reflector

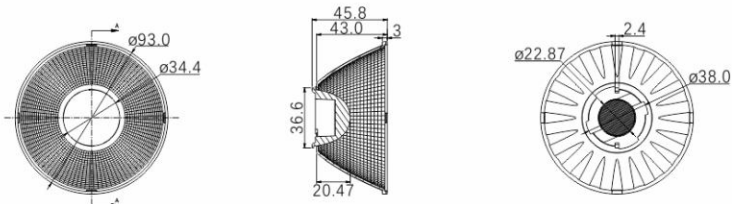

光源/SOURCE / LES 10-18mm

| | |
|-----------|---|
| Bridgelux | E8 CA / E15 / V13 gen7-gen8-gen9 / V15 gen7-gen8-gen9 / V9 HD gen7-gen8 / V11 HD gen8 |
| Citizen | CLU723 / CLU721 / CLU038 / CLU033 / CLU03Q |
| CREE | CXB1507 / CXB1520 / CXB1816 / CXB1830 / CHA0825 / CMA1516 / CMA1825 / CMB1507 / CMB1516 / CMU1818 / CMB1825 / CMT1922 / CMT1930 / CMU1519 / CMU1526 |
| Lumens | ERC1507HO / ERC1512HO / ERC1812HO / ERC1820HO / 2025H2 / 2032H2 |
| Lumileds | 12025 / 1204 / 1205 / 1208 / S04H9 / M02F09 / M03F09 / L06x13 / L08x15 / L10x15 |

| | |
|----------|---|
| Luminus | CHM-9-BH40 / CXM-11 gen4 / CXM-11 LUX / CIM-14-AC30 gen3 / CXM-14-AC30 gen3 / CXM-14 gen4 / CGM-14 gen6 / CIM-14 gen6 / CLM-14-TC50 LUX |
| Osram | S9 / S14 / S19 |
| Nichia | NFCWL036B / NVEWL016Z / NFCWL060B / NVCWL024Z |
| Tridonic | SLE 13mm / SLE 15mm |
| Samsung | LC020C / LC030C / LC016D / LC019D / LC026D / LC033D |
| Seoul | SAWS1564A / SAWS1566A |

支架/HOLDERS

| Type | COB size(mm) | COB LES(mm) | Size(mm) | Material | Screw size |
|------------|---------------------|-------------|-----------|----------|------------|
| BRHV013-A | 15.8×15.8 | 10-14 | ø40×2 | PA9T | M3 |
| BRHV013-C | 15.85×15.85 | 10-15 | ø36.2×2.0 | PC | M3 |
| BCH1330-A | 19×19 | 10-17 | ø40×2 | PA9T | M3 |
| CIHL030-A | 19×19 | 10-17 | ø36.2×2 | PA9T | M3 |
| BRHV1518-A | 21×21 | 14-19 | ø50×2.0 | PA9T | M3 |
| BCHV1825-A | 24×24 | 16-21 | ø50×2.0 | PA9T | M3 |
| LSHM9MI-A | 15×15 / 15×12 | 8-11 | 50×44×2.2 | PC | M3 |
| CRH1830-A | 15.85×15.85 / 18×18 | 10-16 | 50×44×2.2 | PC | M3 |
| LUH1114-A | 18.5×18.5 / 18.5×15 | 10-16 | 50×44×2.2 | PC | M3 |
| CIHL030-B | 19×19 / 21×21 | 10-17 | 50×44×2.2 | PC | M3 |
| SHHMEGA-PC | 24×24 / 24×20 | 12-22 | 50×44×2.2 | PC | M3 |

BR105-C1C

| Model型号 | FWHM Angle角度 | Lens透镜 | Cover灯盖 |
|-------------|--------------|--------|-------------|
| BR10520-C1C | 20° | | |
| BR10540-C1C | 40° | - | Transparent |
| BR10560-C1C | 60° | | |

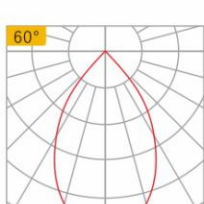
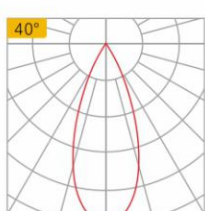
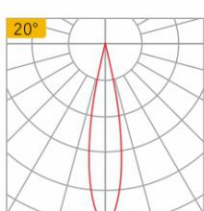

P.46 | Reflector

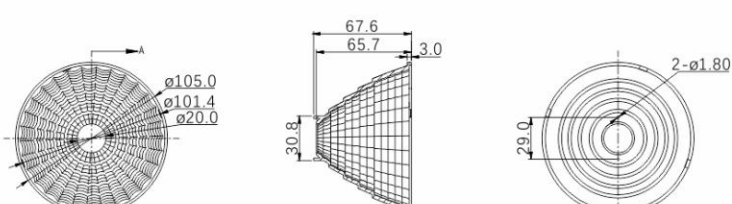

光源/SOURCE / LES 13-18mm

| | |
|-----------|---|
| Bridgelux | E10 / V15 gen7-gen8-gen9 / V9 HD gen7-gen8 / V11 HD gen8 / Vero18 |
| Citizen | CLU038 / CLU033 / CLU03Q |
| CREE | CMA1840 / CMB1840 / CMT1925 / CMT1940 / CMU1516 / CMU1519 / CMU1526 |
| Lumens | 2032H2 |
| Lumileds | 1204 / 1205 / 1208 / L08F14 / L08x15 / L10x15 |

| | |
|----------|--|
| Luminus | CIM-14-AC30 gen3 / CLM-14-AC30 gen3 / CXM-14-AC30 gen3 / CIM-14 gen4 / CGM-14 gen4 / CXM-14 gen4 / CGM-14 gen6 / CIM-14 gen6 / CLM-14 gen6 / CLM-14-TC50 LUX |
| Osram | S14 |
| Nichia | NFCWJ108B / NFDWJ130B / NVEWJ048Z |
| Tridonic | SLE 15mm |
| Samsung | LC016D / LC019D / LC026D / LC033D |
| Seoul | SAWS1564A / SAWS1566A |

支架/HOLDERS

| Type | COB size(mm) | COB LES(mm) | Size(mm) | Material | Screw size |
|-------------|--------------|-------------|---------------|----------|------------|
| CRH1816-P | 17.85×17.85 | 10-15 | ø36.2×4.1 | PC | M2.5 |
| BCH1330-A | 19×19 | 10-17 | ø40×2.0 | PA9T | M3 |
| CIHL030-A | 19×19 | 10-17 | ø36.2×2 | PA9T | M3 |
| CIHL030-P | 19×19 | 10-17 | 29.4×29.4×3.2 | PC | M3 |
| H161919B-01 | 19×19 | 10-16 | ø35×3.5 | PC | M3 |
| BRHV1518-A | 21×21 | 14-19 | ø50×2.0 | PA9T | M3 |
| BRHV015-P | 21×21 | 14-17 | ø36.2×3.0 | PC | M2.5 |
| TRH0017-P | 21×21 | 14-17 | ø36×3.2 | PC | M2.5 |
| SAHC026-P | 21.5×21.5 | 14-18 | ø34×4.4 | PC | M2.5 |
| NIHN216-P | 24×19 | 14-18 | ø36.2×3.0 | PC | M2.5 |
| H182420A-01 | 24×20 | 14-18 | ø35×3.2 | PC | M2.5 |
| PIH1208-P | 24×20 | 14-17 | ø36.2×4.0 | PC | M2.5 |
| SHHMEGA-P | 24×20 | 12-17 | ø35×3.7 | PC | M3 |
| CRH2520-P | 24×24 | 14-18 | ø38×2.9 | PC | M2.5 |

BR110-C1C

| Model型号 | FWHM Angle角度 | Lens透镜 | Cover灯盖 |
|-------------|--------------|--------|-------------|
| BR11018-C1C | 18° | | |
| BR11028-C1C | 28° | - | Transparent |
| BR11040-C1C | 40° | | |

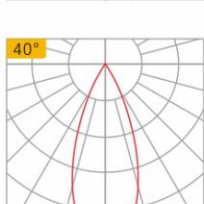
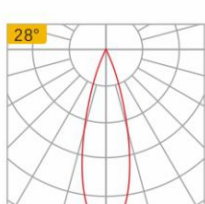
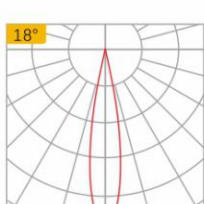

P.47 | Reflector

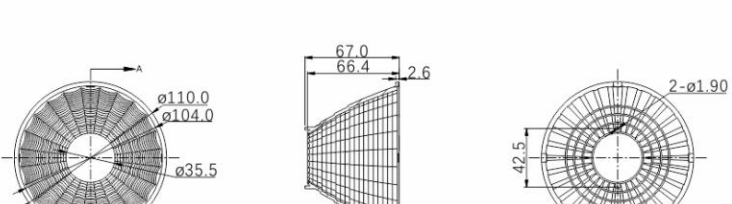

光源/SOURCE / LES 30-34mm

| | |
|-----------|------------------|
| Bridgelux | Vero29 gen7-gen8 |
|-----------|------------------|

CO110-C1C

| Model型号 | FWHM Angle角度 | Lens透镜 | Cover灯盖 |
|-------------|--------------|--------|-------------|
| CO11018-C1C | 18° | | |
| CO11028-C1C | 28° | - | Transparent |
| CO11038-C1C | 38° | | |

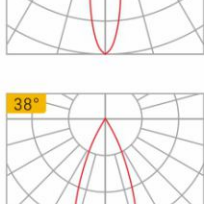
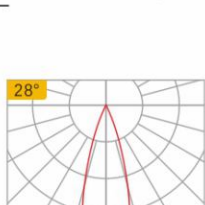
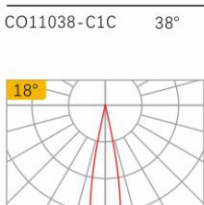

P.48 | Reflector

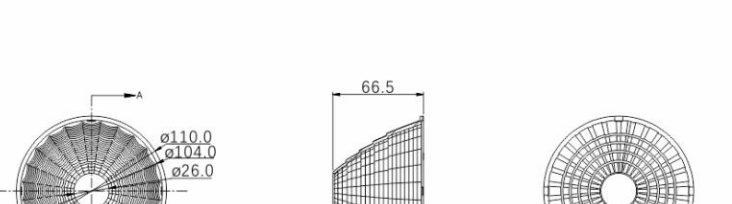

光源/SOURCE / LES 22-25mm

| | |
|-----------|---|
| Bridgelux | E22 / V22 gen7-gen8-gen9 |
| Citizen | CLU048 / CLU041 / CLU04Q |
| CREE | CXB3070 / CMA3090 / CMB3090 / CMT2890 / CMU2287 |
| Lumens | ERC3050HO / ERC3070HO |
| Lumileds | 1213 / 1216 / 1812 |

| | |
|----------|---|
| Luminus | CLM-22 gen3 / CXM-22 gen3 / CGM-22 gen4 / CIM-22 gen4 / CLM-22 gen4 / CXM-22 gen4 / CGM-22 gen6 / CIM-22 gen6 / CLM-22 gen6 / CXM-22 gen6 / CLM-22-TC50 LUX |
| Tridonic | SLE 21mm |
| Seoul | SAWS226AA |

支架/HOLDERS

| Type | COB size(mm) | COB LES(mm) | Size(mm) | Material | Screw size |
|-----------|--------------|-------------|----------|----------|------------|
| TRH0023-P | 31×31 | 20-27 | ø46×3.5 | PC | M3 |

BC110-C1C

| Model型号 | FWHM Angle角度 | Lens透镜 | Cover灯盖 |
|-------------|--------------|--------|-------------|
| BC11018-C1C | 18° | | |
| BC11028-C1C | 28° | - | Transparent |
| BC11040-C1C | 40° | | |

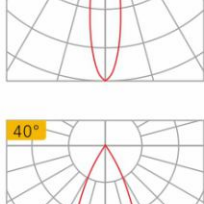
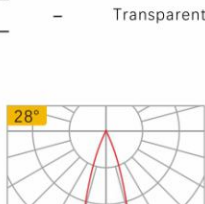
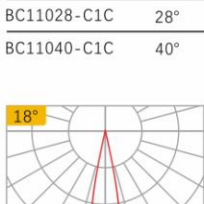

P.49 | Reflector

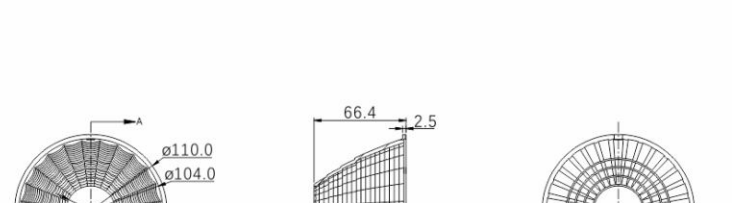

光源/SOURCE / LES 30-34mm

| | |
|----------|---|
| CREE | CXB3590 |
| Lumileds | 1321 |
| Luminus | CXM-32 gen3 / CXM-32 gen4 / CXM-32 gen6 |



P90528

| Model型号 | FWHM Angle角度 | Lens透镜 | Cover灯盖 |
|---------|--------------|--------|---------|
| P90528 | 60° | - | - |



光源/SOURCE / LES 12-18mm

| | |
|-----------|---|
| Bridgelux | E10 / V15 gen7-gen8-gen9 / V9 HD gen7-gen8 / V11 HD gen8 / Vero18 |
| Citizen | CLU038 / CLU033 / CLU03Q |
| CREE | CMA1840 / CMB1840 / CMT1925 / CMT1940 / CMU1516 / CMU1519 / CMU1526 |
| Lumens | 2032H2 |
| Lumileds | 1204 / 1205 / 1208 / L08F14 / L08x15 / L10x15 |

| | |
|----------|--|
| Luminus | CIM-14-AC30 gen3 / CLM-14-AC30 gen3 / CXM-14-AC30 gen3 / CIM-14 gen4 / CGM-14 gen4 / CXM-14 gen4 / CGM-14 gen6 / CIM-14 gen6 / CLM-14 gen6 / CLM-14-TC50 LUX |
| Osram | S14 |
| Nichia | NFCWJ108B / NFDWJ130B / NVEWJ048Z |
| Tridonic | SLE 15mm |
| Samsung | LC016D / LC019D / LC026D / LC033D |
| Seoul | SAWS1564A / SAWS1566A |

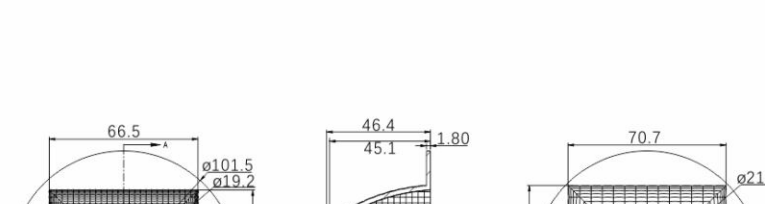

P.50 | Reflector



P90529

Model型号 FWHM Angle角度 Lens透镜 Cover灯盖

P90529 85° - -

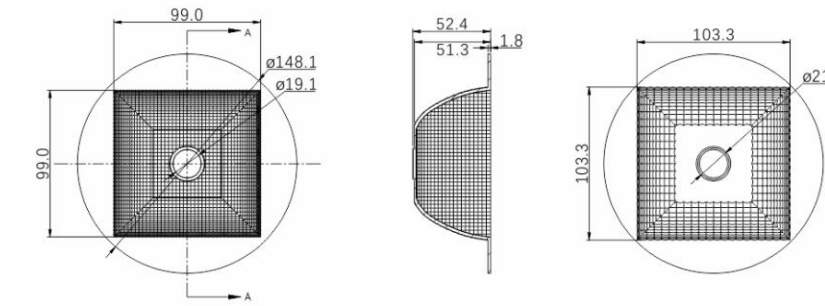
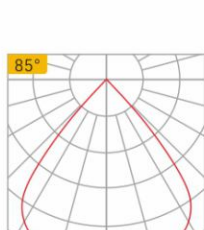

光源/SOURCE / LES 12-18mm

| | |
|-----------|--|
| Bridgelux | E10 / V15 gen7·gen8·gen9 V9 HD gen7·gen8 / V11 HD gen8 / Vero18 |
| Citizen | CLU038 / CLU031 / CLU03Q |
| CREE | CMA1840 / CMB1840 / CMT1925 / CMT1940 CMU1516 / CMU1519 / CMU1526 |
| Lumens | 2032H2 |
| Lumileds | 1204 / 1205 / 1208 / L08F14 / L08x15 / L10x15 |

| | |
|----------|--|
| Luminus | CIM-14-AC30 gen3 / CLM-14-AC30 gen3 CXM-14-AC30 gen3 / CIM-14 gen4 CGM-14 gen4 / CCM-14 gen4 CGM-14 gen6 / CIM-14 gen6 / CLM-14 gen6 CXM-14 gen6 / CLM-14-TC50 LUX |
| Osram | S14 |
| Nichia | NFCWJ108B / NFDWJ130B / NVEWJ048Z |
| Tridonic | SLE 15mm |
| Samsung | LC016D / LC019D / LC026D / LC033D |
| Seoul | SAWS1564A / SAWS1566A |

P.51 | Reflector



L019A-00

Model型号 FWHM Angle角度 Material材料 Efficiency效率

L01912A-00 12°
L01924A-00 24° PC 88%
L01936A-00 36°

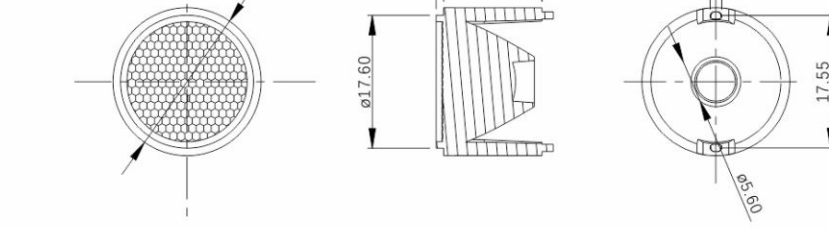
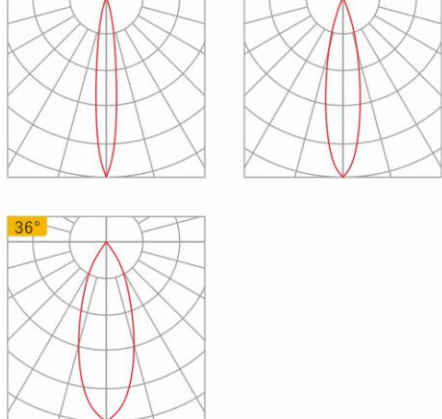

光源/SOURCE

| | |
|---------|--|
| CREE | XP-G2 / XP-G3 / XP-E / XT-E / XP-E2 / XP-C / XP-L2 / XP-LHI / XP-P |
| Luminus | SST-20 |
| Nichia | NVSW119F / NCSA119B / NVSA119B / NV4WB35AM |
| Samsung | LH351 |

P.52 | Lens



L035A-00

Model型号 FWHM Angle角度 Material材料 Efficiency效率

L03518A-00 18°
L03524A-00 24° PMMA 88%
L03536A-00 36°
L03560A-00 60°

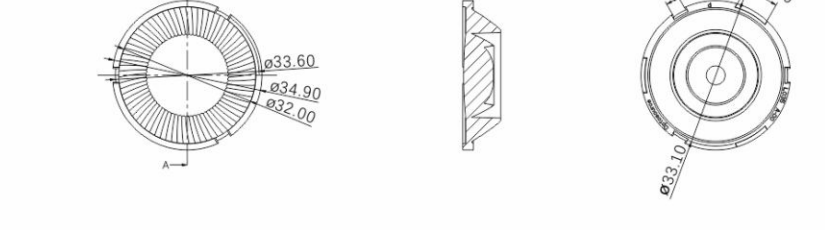
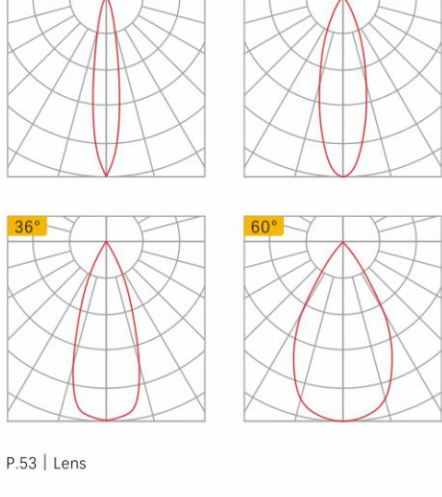

光源/SOURCE / LES 3-6mm

| | |
|-----------|---|
| Bridgelux | V3 HD gen8 / V4 HD gen8 |
| Citizen | CLU7A2 / CLU7A3 |
| CREE | CHA0304 / CHA0410 / CHA0612 |
| Luminus | CXM-3 Gen4 / CXM-4 Gen4·Gen6 CHM-4-BH40 / CXM-4-TE50 LUX |
| Tridonic | SLE 4mm |

光源/SOURCE / LES 7-11mm

| | |
|-----------|--|
| Bridgelux | V6 HD Gen7·gen8 / V10·gen7·gen8·gen9 / E10 |
| Citizen | CLU02B / CLU02J / CLU02Q / CLU703 / CLU702 / CLU701 |
| CREE | CHA0825 / CMT1407 / CMT1420 / CMU1003 / CMU1013 |
| Lumens | 1309H2 / 1318H2 |
| Lumileds | L02x06 / L04x09 |
| Luminus | CXM-6-AC30 gen3 / CXM-6 gen4 CXM-6 gen6 / CHM-6-BH40 / CXM-6 LUX CHM-9 gen3 / CIM-9 gen4 / CIM-9 gen3 CLM-9-AC30 gen3 / CLM-9-AC40 gen4 CXM-9-AC40 gen4 / CLM-9 gen6 CXM-9-TC60 gen6 / CLM-9-TC50 Lux |
| Osram | S9 |
| Samsung | LC010C / LC003D / LC006D / LC009D / LC013D |
| Seoul | SAWS0661A / SAWS1063A |
| Tridonic | SLE 6mm / SLE 9MM / SLE G7 09MM |

支架/HOLDERS

| Type | COB size(mm) | COB LES(mm) | Size(mm) | Material | Screw size |
|-------------|--------------|-------------|----------|----------|------------|
| H121313H-01 | 13.5×13.5 | 6-11 | ø35×3.5 | PC | M3 |

P.53 | Lens



L050A-00

Model型号 FWHM Angle角度 Material材料 Efficiency效率

L05017A-00 17°
L05024A-00 24° PMMA 88%
L05036A-00 36°
L05060A-00 60°

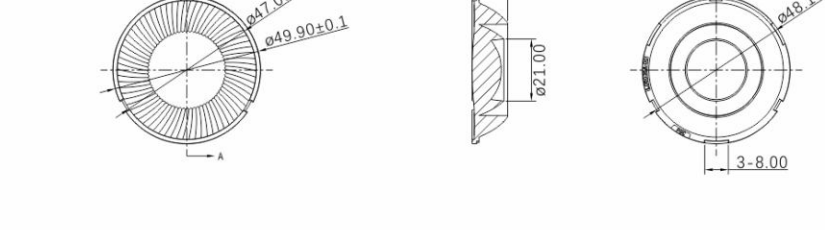
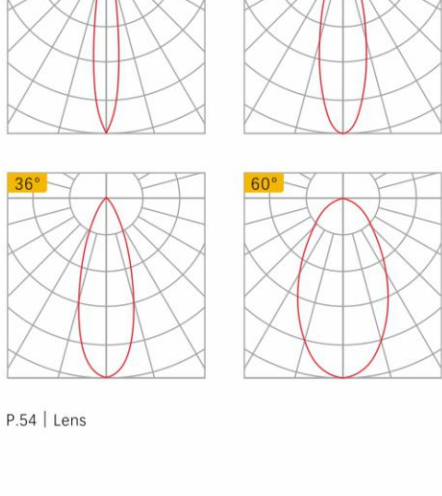

光源/SOURCE / LES 7-11mm

| | |
|-----------|---|
| Bridgelux | V6 HD Gen7·gen8 / V10·gen7·gen8·gen9 / E10 |
| Citizen | CLU02B / CLU02J / CLU02Q / CLU703 / CLU702 / CLU701 |
| CREE | CHA0825 / CMT1407 / CMT1420 / CMU1003 / CMU1013 |
| Lumens | 1309H2 / 1318H2 |
| Lumileds | L02x06 / L04x09 |
| Luminus | CXM-6-AC30 gen3 / CXM-6 gen4 / CXM-6 gen6 CHM-6-BH40 / CXM-6 LUX / CXM-9 gen3 / CIM-9 gen4 CIM-9 gen3 / CLM-9-AC30 gen3 / CLM-9-AC40 gen4 CXM-9-AC40 gen4 / CLM-9 gen6 CXM-9-TC60 gen6 / CLM-9-TC50 Lux |
| Osram | S9 |
| Samsung | LC010C / LC003D / LC006D / LC009D / LC013D |
| Seoul | SAWS0661A / SAWS1063A |
| Tridonic | SLE 6mm / SLE 9MM / SLE G7 09MM |

支架/HOLDERS

| Type | COB size(mm) | COB LES(mm) | Size(mm) | Material | Screw size |
|-------------|--------------|-------------|----------|----------|------------|
| H121313H-01 | 13.5×13.5 | 7-11 | ø35×3.5 | PC | M3 |

P.54 | Lens

支架/HOLDERS

| | | | | |
|---------------------------------------|---------------------------------------|---------------------------|---|-------------------------|
| | | | | |
| Type: BCH1015-P | Type: BCH6813-P | Type: BRHV010-P | Type: BRHV013-C | Type: BRHV015-P |
| COB size(mm): 13.5×13.5 / 15.85×15.85 | COB size(mm): 12.5×12.5 / 13.35×13.35 | COB size(mm): 15.8×15.8 | COB size(mm): 15.85×15.85 | COB size(mm): 21×21 |
| COB LES(mm): 6-11 | COB LES(mm): 4-9 | COB LES(mm): 3-12 | COB LES(mm): 10-15 | COB LES(mm): 12-17 |
| Size(mm): ø30.5×6.7 | Size(mm): ø30.5×6.7 | Size(mm): ø28×3.5 | Size(mm): ø36.2×2.0 | Size(mm): ø36.2×3.0 |
| Material: PC | Material: PC | Material: PC | Material: PC | Material: PC |
| | | | | |
| Type: BRHV068-PA | Type: BRHV068-PD | Type: CIH1020-P | Type: CIH1030-B | Type: CIH1030-P |
| COB size(mm): 12.5×12.5 | COB size(mm): 12.5×12.5 | COB size(mm): 13.5×13.5 | COB size(mm): 19.19 / 21×21 | COB size(mm): 19×19 |
| COB LES(mm): 3-9 | COB LES(mm): 3-9 | COB LES(mm): 3-11.5 | COB LES(mm): 10-17 | COB LES(mm): 10-17 |
| Size(mm): 20.2×20×3.8 | Size(mm): 25.6×23.2×3.7 | Size(mm): ø25×3.2 | Size(mm): 50×44×2.2 | Size(mm): 29.4×29.4×3.2 |
| Material: PC | Material: PC | Material: PC | Material: PC | Material: PC |
| | | | | |
| Type: CRH1304-P | Type: CRH1507-P | Type: CRH1816-P | Type: CRH1830-A | Type: CRH2520-P |
| COB size(mm): 13.35×13.35 | COB size(mm): 15.85×15.85 | COB size(mm): 17.85×17.85 | COB size(mm): 15.85×15.85 / 17.85×17.85 | COB size(mm): 24×24 |
| COB LES(mm): 3-8.5 | COB LES(mm): 3-11 | COB LES(mm): 10-15 | COB LES(mm): 10-17 | COB LES(mm): 14-18 |
| Size(mm): 20.2×20.2×5.0 | Size(mm): ø25×4.3 | Size(mm): ø36.2×4.1 | Size(mm): 50×44×2.2 | Size(mm): ø38×2.9 |
| Material: PC | Material: PC | Material: PC | Material: PC | Material: PC |

P.55 | Holders

| | | | | |
|---------------------------|-------------------------------------|-------------------------|-------------------------|-----------------------------|
| | | | | |
| Type: H081313E-01 | Type: H101313A-01 | Type: H101512E-01 | Type: H111512D-01 | Type: H111616A-01 |
| COB size(mm): 13.35×13.35 | COB size(mm): 12.5×12.5 | COB size(mm): 15×12 | COB size(mm): 15×12 | COB size(mm): 15.85×15.85 |
| COB LES(mm): 3-7.5 | COB LES(mm): 3-9 | COB LES(mm): 3-9 | COB LES(mm): 3-11 | COB LES(mm): 3-11 |
| Size(mm): ø25×3.6 | Size(mm): ø25×3.5 | Size(mm): ø25×3.2 | Size(mm): ø25×3.2 | Size(mm): ø27.5×3.2 |
| Material: PC | Material: PC | Material: PC | Material: PC | Material: PC |
| | | | | |
| Type: H111616C-01 | Type: H121313E-01 | Type: H121414E-01 | Type: H121414I-01 | Type: H121616B-01 |
| COB size(mm): 15.85×15.85 | COB size(mm): 13.5×13.5 / 12.5×12.5 | COB size(mm): 13.5×13.5 | COB size(mm): 13.5×13.5 | COB size(mm): 15.85×15.85 |
| COB LES(mm): 3-11 | COB LES(mm): 3-11 | COB LES(mm): 3-12 | COB LES(mm): 8-11.5 | COB LES(mm): 3-12 |
| Size(mm): ø25×4.0 | Size(mm): ø35×4.3 | Size(mm): ø27×4.0 | Size(mm): ø30.5×6.7 | Size(mm): ø32×3.5 |
| Material: PC | Material: PC | Material: PC | Material: PC | Material: PC |
| | | | | |
| Type: H161919A-01 | Type: H161919B-01 | Type: H182420A-01 | Type: H252828A-01 | Type: LSHM9M-A |
| COB size(mm): 19×19 | COB size(mm): 19×19 | COB size(mm): 24×20 | COB size(mm): 28×28 | COB size(mm): 15×15 / 15×12 |
| COB LES(mm): 8-16 | COB LES(mm): 8-16 | COB LES(mm): 14-18 | COB LES(mm): 22-25 | COB LES(mm): 8-11 |
| Size(mm): ø40×3.2 | Size(mm): ø35×3.5 | Size(mm): ø35×3.2 | Size(mm): ø50×4.2 | Size(mm): 50×44×2.2 |
| Material: PC | Material: PC | Material: PC | Material: PC | Material: PC |

P.56 | Holders

| | | | | |
|---|---|---|---|--|
|  |  |  |  |  |
| Type: LUH1114-A | Type: NIHN036-P | Type: NIHN066-P | Type: NIHN121-P | Type: NIHN216-P |
| COB size(mm): 18.5×18.5 / 18.5×15 | COB size(mm): 19×16 | COB size(mm): 19×16 | COB size(mm): 19×16 | COB size(mm): 24×19 |
| COB LES(mm): 10-16 | COB LES(mm): 3-11 | COB LES(mm): 3-11 | COB LES(mm): 10-15 | COB LES(mm): 14-18 |
| Size(mm): 50×44×2.2 | Size(mm): ø30.2×3.0 | Size(mm): ø30.2×3.0 | Size(mm): ø37.6×3.7 | Size(mm): ø36.2×3.0 |
| Material: PC | Material: PC | Material: PC | Material: PC | Material: PC |

| | | | | |
|---|---|---|---|--|
|  |  |  |  |  |
| Type: PIH1203-P | Type: PIH1204-P | Type: PIH1208-P | Type: SAHC026-P | Type: SAHL013-P |
| COB size(mm): 19×16 | COB size(mm): 24×20 | COB size(mm): 24×20 | COB size(mm): 21.5×21.5 | COB size(mm): 17×17 |
| COB LES(mm): 3-11 | COB LES(mm): 12-15 | COB LES(mm): 14-17 | COB LES(mm): 14-18 | COB LES(mm): 10-13 |
| Size(mm): ø30.2×3.2 | Size(mm): ø37.6×4.1 | Size(mm): ø36.2×4.0 | Size(mm): ø34×4.4 | Size(mm): ø37.6×3.7 |
| Material: PC | Material: PC | Material: PC | Material: PC | Material: PC |

| | | | | |
|---|---|---|---|--|
|  |  |  |  |  |
| Type: SHHMEGA-P | Type: SHHMINI-P | Type: SHHMEGA-PC | Type: TRH0017-P | Type: TRH0023-P |
| COB size(mm): 24×20 | COB size(mm): 15×12 | COB size(mm): 24×24 / 24×20 | COB size(mm): 21×21 | COB size(mm): 31×31 |
| COB LES(mm): 12-17 | COB LES(mm): 3-10 | COB LES(mm): 12-22 | COB LES(mm): 14-17 | COB LES(mm): 20-27 |
| Size(mm): ø35×3.7 | Size(mm): ø25.6×2.0 | Size(mm): 50×44×2.2 | Size(mm): ø36×3.2 | Size(mm): ø46×3.5 |
| Material: PC | Material: PC | Material: PC | Material: PC | Material: PC |

P.57 | Holders

| | | | |
|---|---|---|---|
|  |  |  |  |
| Type: H111212A-01 | Type: H121313H-01 | Type: H121313H-01 (L035转换件) | Type: H121313H-01 (L050转换件) |
| COB size(mm): 12.8×12.8 | COB size(mm): 13.5×13.5 | COB size(mm): 13.5×13.5 | COB size(mm): 13.5×13.5 |
| COB LES(mm): 3-10.5 | COB LES(mm): 6-11 | COB LES(mm): 6-11 | COB LES(mm): 6-11 |
| Size(mm): ø25×4 | Size(mm): ø35×3.5 | Size(mm): ø35×3.5 | Size(mm): ø35×3.5 |
| Material: PC | Material: PC | Material: PC | Material: PC |

P.58 | Holders

■ 免焊接支架/SOLDER-FREE HOLDERS

| | | | | |
|---|---|---|---|--|
|  |  |  |  |  |
| Type: BCH1020-A | Type: BCH1330-A | Type: BCHV1825-A | Type: BRHV010-C | Type: BRHV068-F |
| COB size(mm): 13.5×13.5 | COB size(mm): 19×19 | COB size(mm): 24×24 | COB size(mm): 15.8×15.8 | COB size(mm): 12.5×12.5 |
| COB LES(mm): 3-11.5 | COB LES(mm): 10-17 | COB LES(mm): 16-21 | COB LES(mm): 3-12 | COB LES(mm): 3-9 |
| Size(mm): ø28×2 | Size(mm): ø40×2 | Size(mm): ø50×2 | Size(mm): ø28×2 | Size(mm): ø28×2 |
| Material: PA9T | Material: PA9T | Material: PA9T | Material: PA9T | Material: PA9T |

| | | | | |
|---|---|---|---|--|
|  |  |  |  |  |
| Type: BRHV1518-A | Type: CHL020-A | Type: CHL030-A | Type: H111512C-02 | Type: H111512G-02 |
| COB size(mm): 21×21 | COB size(mm): 13.5×13.5 | COB size(mm): 19×19 | COB size(mm): 15×12 | COB size(mm): 15×12 |
| COB LES(mm): 12-19 | COB LES(mm): 3-11.5 | COB LES(mm): 10-17 | COB LES(mm): 3-12 | COB LES(mm): 3-9 |
| Size(mm): ø50×2 | Size(mm): ø28×2 | Size(mm): ø36.2×2 | Size(mm): ø28×2 | Size(mm): ø40×4.8 |
| Material: PA9T | Material: PA9T | Material: PA9T | Material: PA9T | Material: PBT |

| | | |
|---|---|---|
|  |  |  |
| Type: H121414B-02 | Type: H192420C-02 | Type: H272828A-02 |
| COB size(mm): 13.5×13.5 | COB size(mm): 24×20 | COB size(mm): 28×28 |
| COB LES(mm): 3-11 | COB LES(mm): 12-18 | COB LES(mm): 20-26 |
| Size(mm): ø28×2 | Size(mm): ø50×4.8 | Size(mm): ø57×8.3 |
| Material: PA9T | Material: PBT | Material: PBT |

P.59 | Solder-Free Holders

我们的案例 THE CASES WE HAVE DONE



如需了解更多案例请联系我们
FOR MORE CASES,
PLEASE FEEL FREE TO CONTACT US IMMEDIATELY.

■ 光源合作伙伴/LED PARTNERS

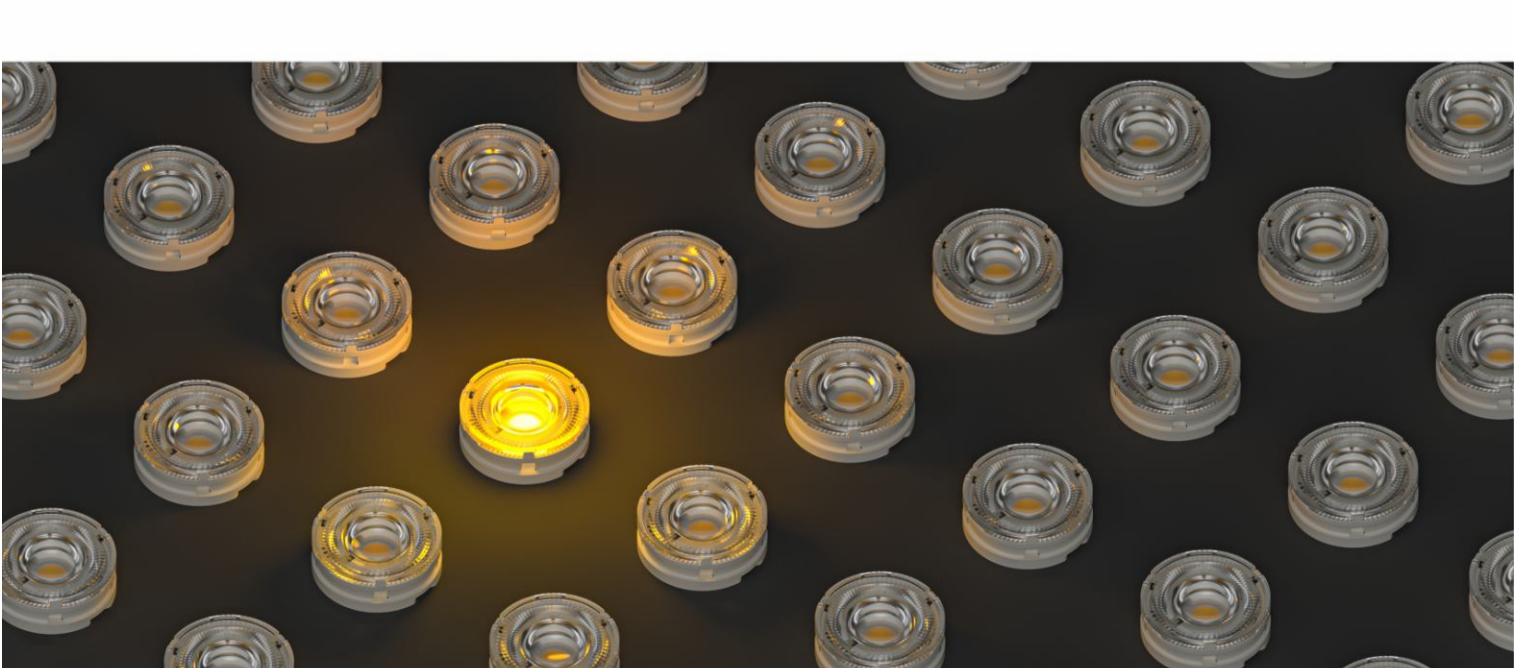

■ 感谢您的阅览

Thank You For Your Attention